

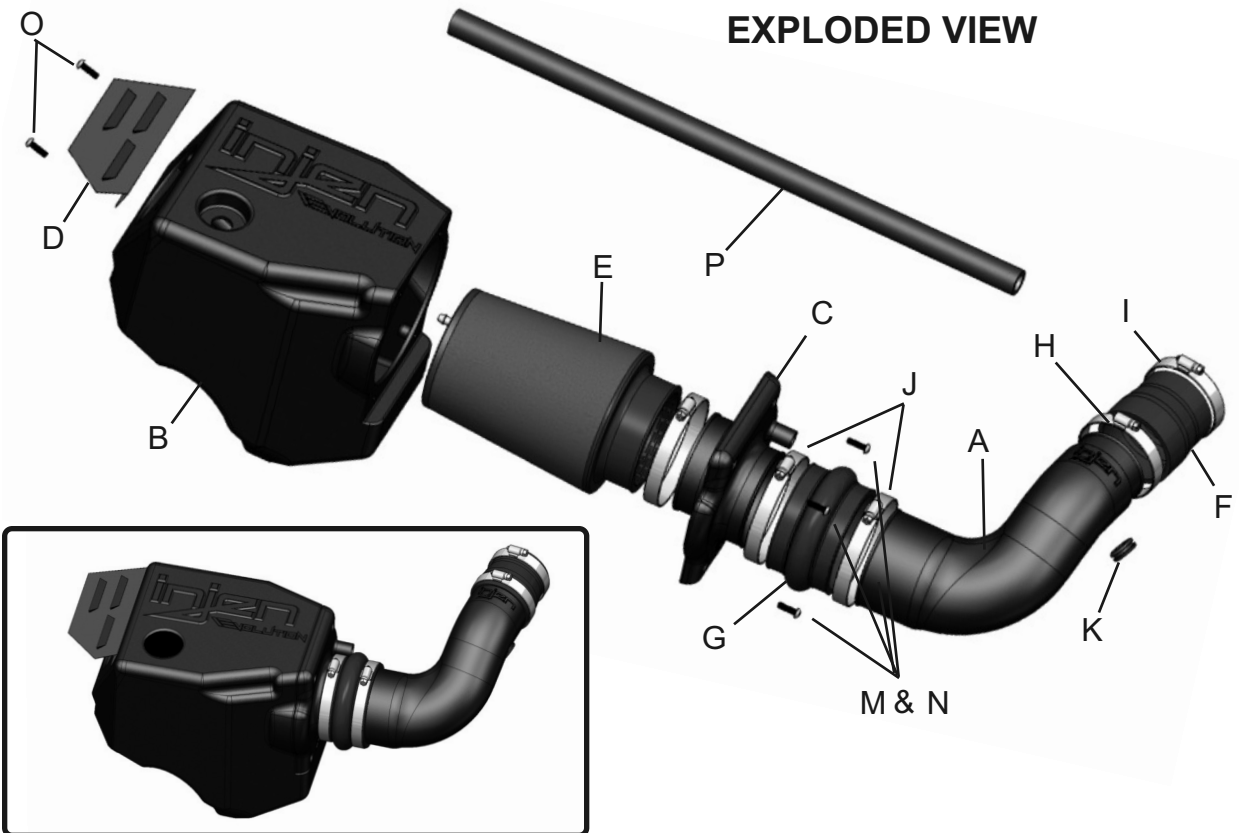

Vehicle Application:
 Make: **Jeep**
 Model: **Wrangler (JK)**
 Year: **2007-2011**
 Engine: **3.8L V6**



Item	QTY.	P/N	Discription
A	1	#15101	Intake Tube
B	1	#15067	Air Box Housing
C	1	#15068	Air Box Plenum
D	1	#11114	Air Box Shield Air Director
E	1	#1127	Web nanofiber Dry filter
F	1	#3040	3.00\" - 2.75\" Step Hose
G	1	#3250	4.00\" Hump hose
H	1	#4004	#48 Clamp
I	1	#4003	#40 Clamp
J	2	#4006	#64 Clamps
K	1	#8026	Grommet
L			NOT USED
M	4	#6100	M6x20mm Phillips pan screws
N	4	#8047	1/2\"OD rubber seal washer
O	2	#6083	M6X10mm Cap Screw
P	1	#3217	17mm hose @ 25\" L

- TOOLS REQUIRED**
- 10mm Ratchet & Socket
 - 8mm nut drive
 - Allen key
 - Flat Blade Screwdriver
 - Phillis Screwdriver

WARNING: FAILURE TO FOLLOW INSTALLATION INSTRUCTIONS AND NOT USING THE PROVIDED HARDWARE MAY DAMAGE THE INTAKE SYSTEM, ENGINE AND COMPONENTS!!!
*Do not attempt to install the intake system while the engine is hot.
 Severe burn could result from touching hot engine components!

Report any defective or missing parts to the authorized Injen dealer you purchased this product from. Before installing any parts of this system, please read the instructions thoroughly. If you have any questions regarding installation, please contact your Injen Technology dealer. Installation DOES require some mechanical skills. A qualified mechanic is always recommended.

A Limited Lifetime Warranty to the original purchaser against defects in material and workmanship on all Injen intake systems excluding the filter element. Any and all warranty coverage is limited to the repair or replacement of the defective part only, at Injen Technology's discretion. The warranty does not cover incidental or consequential damages, nor does it cover the cost of installation or removal of the defective part or its replacement. Proof of purchase is required.

Instruction Manual P/N:EVO5007

NOTE: This intake kit may not work on vehicles with the following aftermarket modifications.

- Aftermarket Intercooler piping
- Aftermarket intercooler
- Turbo upgrade
- Modified body panels
- Suspension & Chassis modifications

Injen intake systems are street legal in most states unless the state is adopting to California Emissions standards. States that have adopted California emission standards include: Arizona, California, Connecticut, District of Columbia, Maine, Maryland, Massachusetts, New Jersey, New Mexico, New York, Oregon, Pennsylvania, Rhode Island, Vermont, and Washington. These states will require an California Air Resource Board Executive Order Number (CARB E.O.) for the legal use of an Injen intake system in your vehicle for use on public roads or highways. These vehicle will be considered "Legal in California only for racing vehicles competition use only, which may never be used upon a public street or highway. **Please keep your factory air box assembly for any future use.**



The SuperNano-Web filter media is a dry synthetic media that outperforms the competition. The media itself is a proprietary base blend of synthetics and cellulose. Cellulose fibers are larger than synthetic fibers, and have larger spaces between the fibers, causing contaminants to load in the depth of the media and plug the airflow path. This creates higher restriction levels and less capacity. The synthetic fibers in the SuperNano-Web media are submicron in diameter and have small interior fiber spaces, which result in more contaminants being captured on the surface of the media. This can help keep restriction levels low as the filter loads with dirt and containments

**A New Generation of Filters
Designed to perform and
filter like no other**

INJEN SuperNano-Web Technology

If you look at the picture to the left, you can see the Nano-fiber web on top of our base media. That web, or SuperNano-Web as we like to call it, helps trap smaller particles and protect your engine.

To Clean your filter:

Carefully remove the filter from the housing. Once removed, wipe down the housing using a clean shop towel, being careful not to knock any dirt and/or debris in the air inlet. Your filters can be cleaned by carefully vacuuming the filter media from the dirty side, or by holding the filter with one hand and carefully blowing the filter media at a 45-degree angle from the clean side using low-pressure shop air (15-20 lbs. psi).

****IT IS IMPORTANT TO NOT USE ANY CLEANERS ON THE SUPERNANO-WEB MEDIA OR APPLY ANY OIL!!!***

NOTE: DISCONNECT BATTERY BEFORE INSTALLATION!!!

Instruction Manual P/N:EVO5007



1. Stock intake system shown.

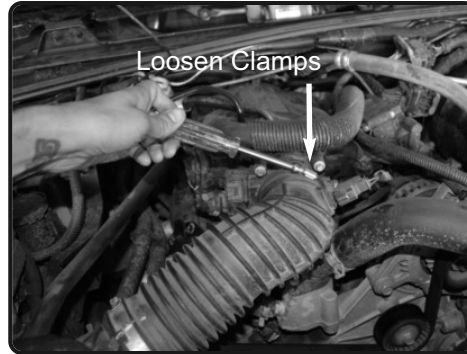

2. Loosen the clamp on the throttle body using 8mm nut driver.



3. Pull back the crank case line from the stock intake box.

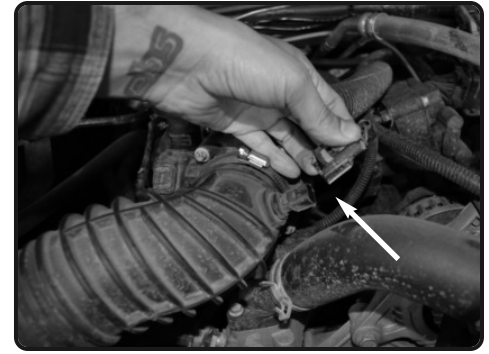

4. Disconnect the temperature sensor from stock intake system. Remove the temperature sensor from the intake tube.



5. Firmly lift up and pull the factory air box assembly out of the engine bay.

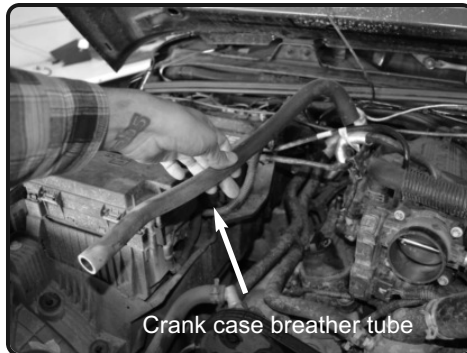

6. Remove the crank case line from the engine fitting.



7. Place the filter onto the air box plenum



8. Secure the filter to the plenum.

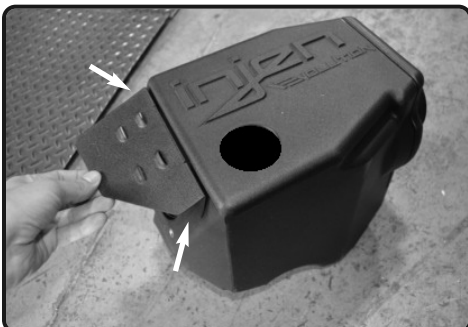

9. Place the Air Box Shield Air Director onto the opening of the air box. Secure the shield to the box with the two supplied M6X10 allen bolts.



10. Insert the filter into the Injen air box. Use four M6X20 bolts and secure the Injen plenum to the Injen air box.



11. Place the Injen air box assembly into the engine bay and line up the pegs below the Injen air box to the factory air box mounting grommets.



12. Place the grommet onto the 7/8" hole on the injen intake pipe and then insert the intake air temp sensor into the grommet

Instruction Manual P/N:EVO5007



13. Place the 4.00" hump hose and two #64 clamps onto the big end of the Injen intake tube. Make sure you slide the hose all the way over onto to tube.



14. Insert the Injen intake tube into the hose on the throttle body and the hump hose on the Injen intake box assembly. Adjust the intake for best fitment and then secure all the clamps.

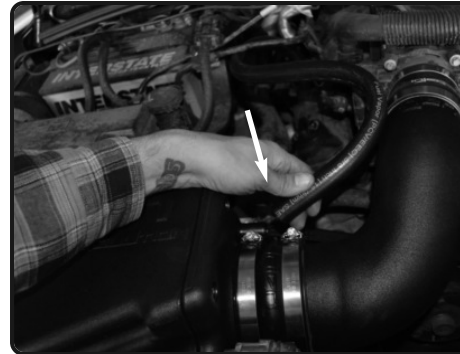

15. Install the provided 15mm hose to the airbox fitting.

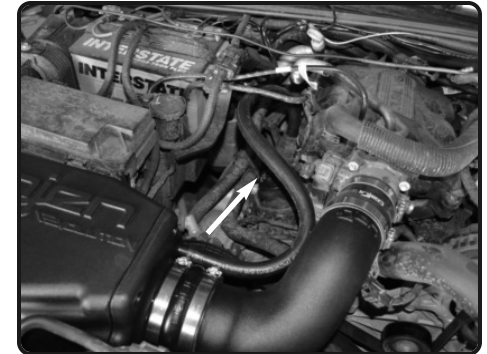

16. Now attach the



17. Reconnect the intake air temp sensor harness to the sensor.



Congratulations! You have just completed the installation of this intake system. Periodically, check the alignment of the intake, normal wear and tear can cause nuts and bolts to come loose. **Note: Check clearance and adjust if needed! Failure to check the alignment and adjust the intake can cause damage that will void the warranty. Injen Technology is not responsible for any damages caused by/from improper installation.**

Test Drive:

1. With the transmission in neutral or park and the parking brake engaged, start the engine. Listen for air leaks or odd noises. If air leaks are detected, secure hoses and connections. For any odd noises, inspect entire system for cause and adjust intake as needed. The Injen intake will function identically to the factory system but will be louder and more powerful.
2. Perform a road test. Listen for odd noises or rattles and fix as necessary.
3. If there are no issues, continue to enjoy your added performance from the Injen performance Intake kit.
4. Injen Technology recommends you periodically check clearance and adjust if needed! Failure to check the alignment and adjust the intake can cause damage that will void the warranty. Injen Technology is not responsible for any damages caused by/from improper installation.

1. Upon completion of the installation, reconnect the negative battery terminal before you start the engine.
2. Align the entire intake system for the best possible fit. Once the intake has been properly fitted continue to tighten all nuts, bolts and clamps.
3. Periodically, recheck the alignment of the intake system and make sure there is proper clearance around and along the length of the intake. Failure to follow proper maintenance procedures may cause damage to the intake and will void the warranty.
4. Start the engine and listen carefully for any odd noises, rattles and/or air leaks prior to taking it for a test drive. If any problems arise go back and check the vacuum lines, hoses and clamps that maybe causing leaks or rattles and correct the problem.
5. Check the filter for excessive dirt build up. Clean or replace the filter with an original Injen filter (can be bought on-line at "injenonline.com"). Congratulations! You have just completed the installation of the best intake system sold on the market. Enjoy the added power and performance of your new intake system.