



Buy products from authorized and licensed manufacturers using any of our patented processes, beware of cheap knock-offs, look for our licensing logo.

MR Technology Step down process:

- 1- Calibration Method for Air Intake Tracts for Internal Combustion Engines. Patent# 7,359,795
- 2- Calibration Device for Air Intake Tracts for Internal Combustion Engines. patented
- 3- Calibration Method and Device for Air Intake Tracts having Air Fusion Inserts patented

**Part number SP1391**

**2010-12 Hyundai genesis 3.8L V6 Coupe ONLY**

The only intake with MR Tech & Air Fusion

- 1- Intake tube
- 1- 4.0" SuperNano-Web Air Filter (#1026)
- 1- Heat shield (#11080)
- 1- Heat shield cover (#11081)
- 1- 3.50"X3.75" Step hose (#3133)
- 1- 3.25"X3.50" Step hose (#3124)
- 4- #56 Clamps (#4005)
- 2- Vibra-Mounts (#6020)
- 4- M6 Flanged nuts (#6002)
- 2- Fender washers (#6010)
- 1- Rubber bulb trim @21.5" Long (#6058)
- 1- Rubber bulb trim @8" Long (#6058)
- 2- M6X20 Button head screws (#6073)
- 3- M6X10 SS Allen screws (#6083)

**Congratulations! You have just purchased the best engineered, dyno-proven cold air intake system available.**

**Please check the contents of this box immediately.**

Report any defective or missing parts to the Authorized Injen Technology dealer you purchased this product from. Before installing any parts of this system, please read the instructions thoroughly. If you have any questions regarding installation please contact the dealer you purchased this product from. Installation DOES require some mechanical skills. A qualified mechanic is always recommended.

\*Do not attempt to install the intake system while the engine is hot. The installation may require removal of radiator fluid line that may be hot.

Injen Technology offers a limited lifetime warranty to the original purchaser against defects in materials and workmanship. Warranty claims must be handled through the dealer from which the item was purchased.

Injen Technology 244 Pioneer Place Pomona, CA 91768 USA

**Note: This intake system was Dyno-tested with an Injen/AMSOIL performance filter. The use of any other filter or part will void the warranty and CARB exemption number.**

All parts and accessories are available on line at "Injenonline.com"

**Note:** The installation of this cold air intake does require mechanical skills. Removal of the front bumper requires loosening and removing several plastic plugs and screws that may be difficult. In addition to removing the bumper, you will also have to remove the air resonator box, battery and tray when beginning this installation. Injen strongly recommends that this system be installed by a professional mechanic.

**MR Technology, "The World's First Tuned air Intake System!"**

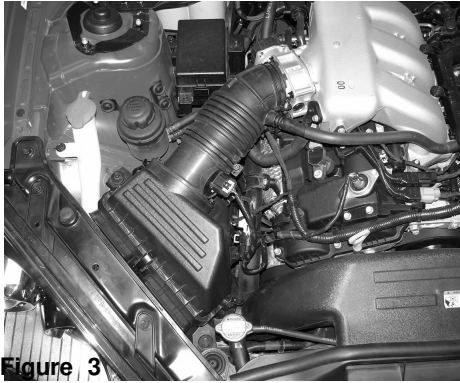
**Factory safe air/fuel ratio's for Optimum performance** Patent# 7,359,795

**Now equipped with "Air Fusion"** Patent pending

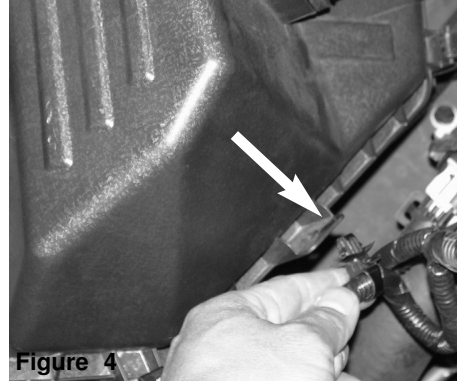
**"At Injen Technology, we didn't copy the step down process, we invented it!"**



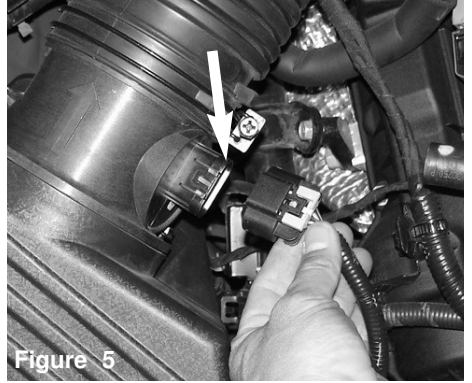
Figure 2



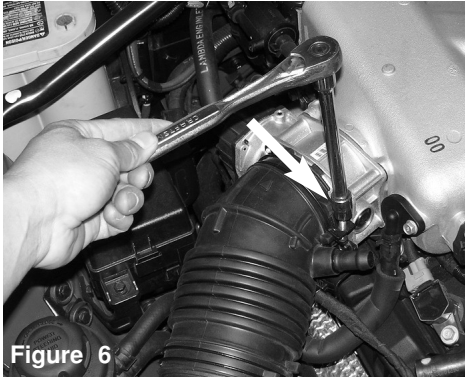
**Figure 3**  
Stock air intake cleaner and air ducts shown in this picture. Before getting started with the installation, disconnect the negative battery terminal.



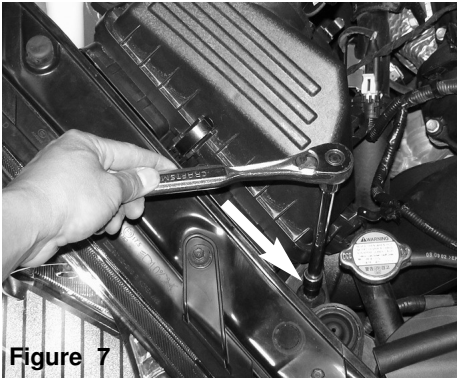
**Figure 4**  
Remove the plastic clip holding the harness to the side of the air box cleaner.



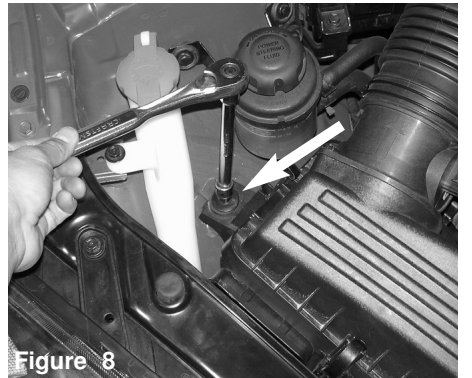
**Figure 5**  
depress the tab on the electrical harness and gently pull on the harness clip.



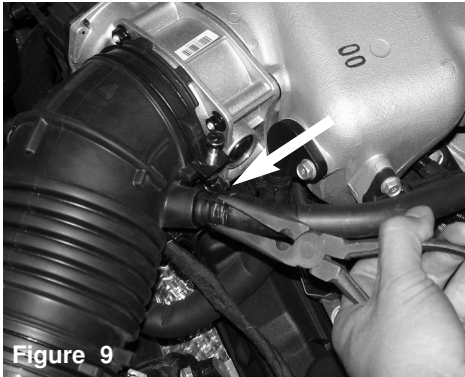
**Figure 6**  
Loosen the clamp on the air intake duct as shown above.



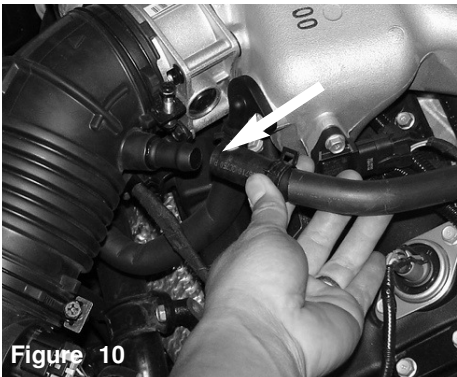
**Figure 7**  
The first bolt in front of the air box cleaner is loosened and removed.



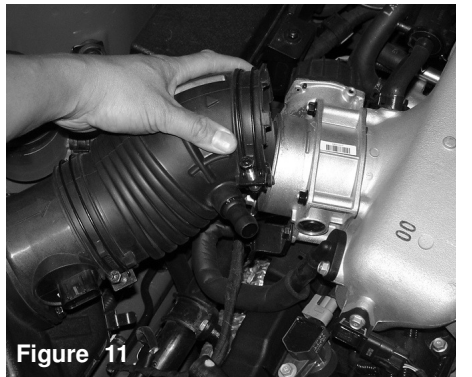
**Figure 8**  
The second m6 bolt located by the wheel well is loosened and removed from the air box cleaner.



**Figure 9**  
The tension clamp on the crankcase vacuum line is compressed and pulled back, this will allow you to remove the hose from the air duct port.



**Figure 10**  
The crankcase vacuum hose is now removed from the air duct port.



**Figure 11**  
The air intake duct is pulled off of the throttle body as shown above.



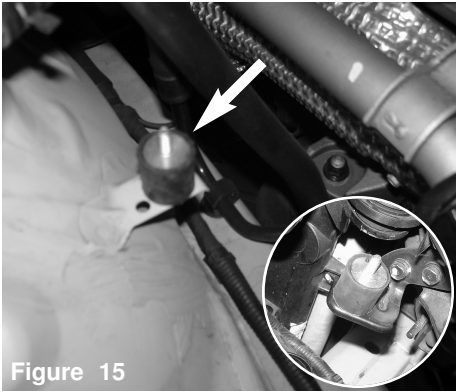
**Figure 12**  
The entire air box and air duct is now ready to be pulled out of the engine compartment.



**Figure 13**  
View of the stock air intake box and air intake duct.

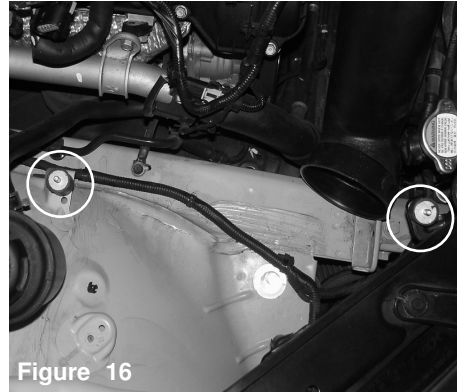


**Figure 14**  
Leave the factory ram air unit. This will be used in the new intake system.



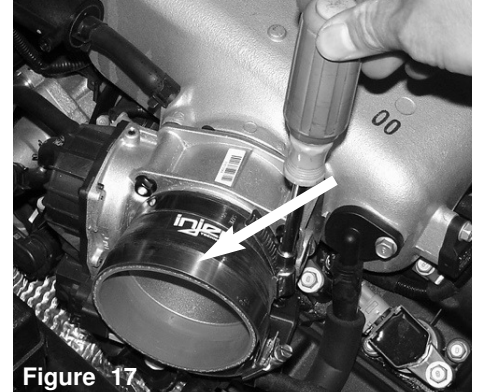
**Figure 15**

Install the vibra mounts to the factory mounting points of the stock air box.



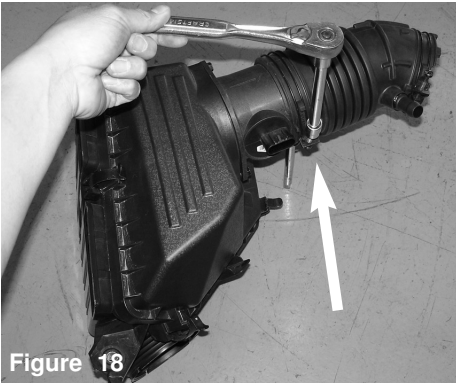
**Figure 16**

Show above is where the 2 will mount. Secure and tighten.



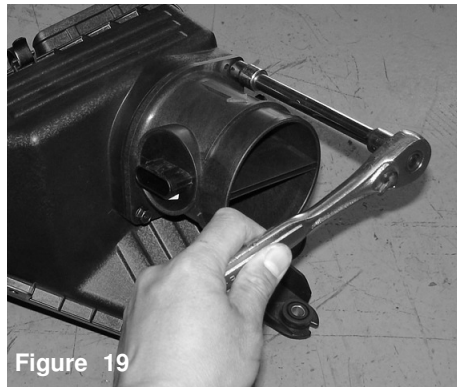
**Figure 17**

Install the silicon step hose to the Throttle body with clamps provided. Use the smaller clamp on the Throttle body and tighten.



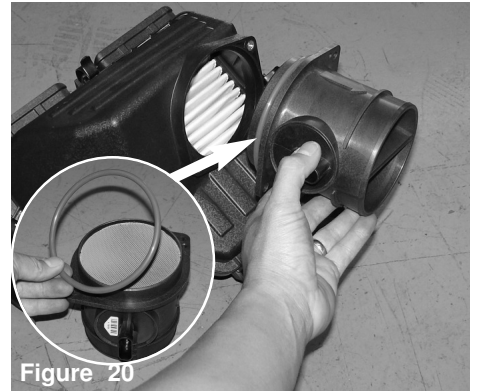
**Figure 18**

The clamp over the air duct is loosened and the air duct is removed.



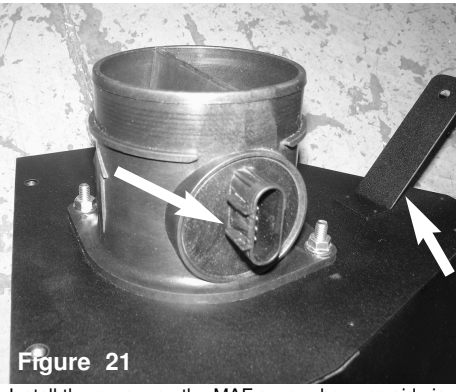
**Figure 19**

The two bolts are loosened and removed from the mass air flow sensor attached to the air box cleaner.



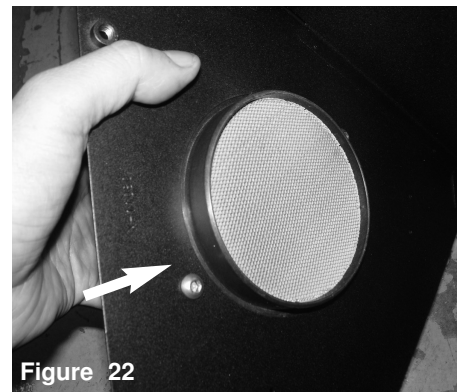
**Figure 20**

Once you have removed the bolts, continue to detach the mass air flow sensor. Remove the ring from the sensor.



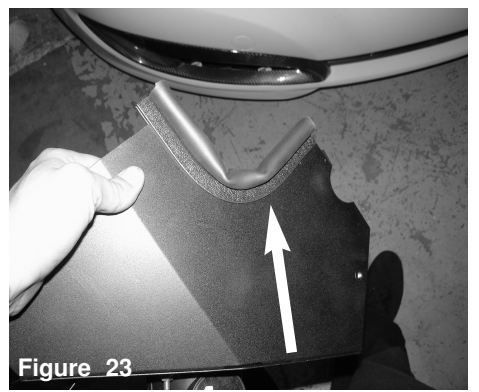
**Figure 21**

Install the sensor so the MAF sensor harness side is facing the engine. Or also look to see arrow on MAF is facing up and going in the direction towards the throttle body. see step 28.



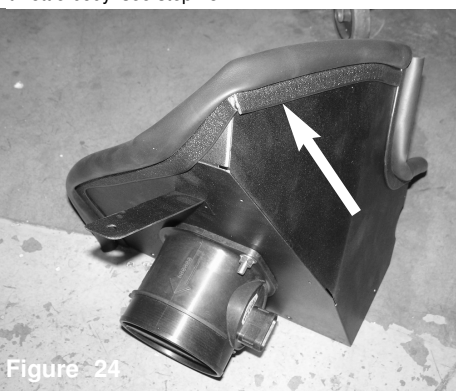
**Figure 22**

Secure the MAF sensor with the button head inside of the housing. This will allow for maximum clearance for the filter. Tighten using provided M6 nuts.



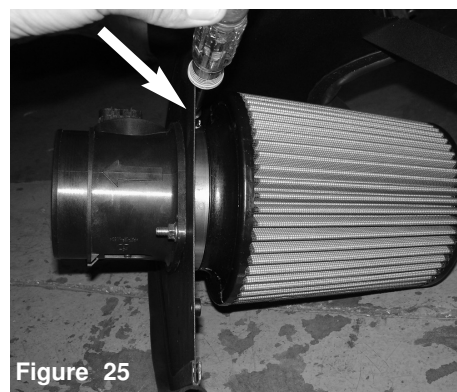
**Figure 23**

Install the 8" long rubber trim to the cut-out on the heat shield.



**Figure 24**

Install the longer trim to the bottom of the heat shield.



**Figure 25**

Install the filter to the MAF sensor. Tighten using 8mm nut driver.



**Figure 26**

Install the heat shield assembly into the vehicle, position the tabs to the vibra mount.



Figure 27

Secure the vibra mounts using provided m6 nuts and fender washers. Tighten using 10mm socket or ratchet.

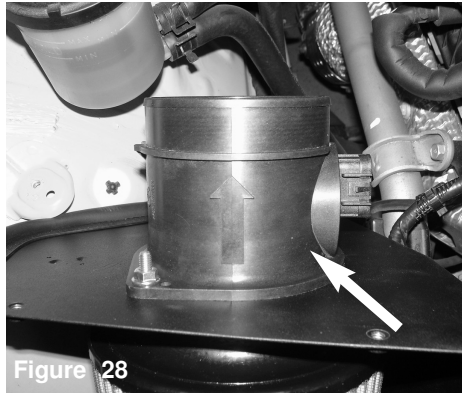


Figure 28

The MAF sensor needs to be positioned like above image or you can damage the sensor. See step 29.

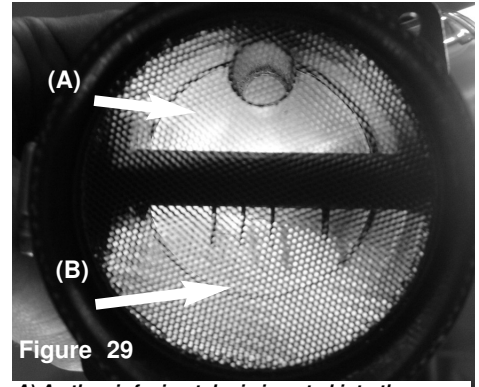


Figure 29

A) As the air fusion tube is inserted into the mass air flow sensor, the tube is placed on the UN-METERED SIDE of the MAF sensor. B) The sensor filaments are shown above.

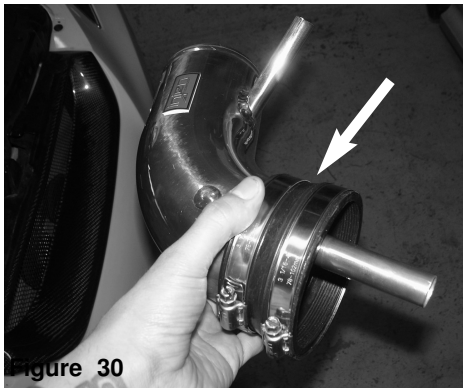


Figure 30

Now install the urethane step hose to the air fusion side of the tube. Tighten the clamp using 8mm nut driver. Install intake assembly into vehicle.

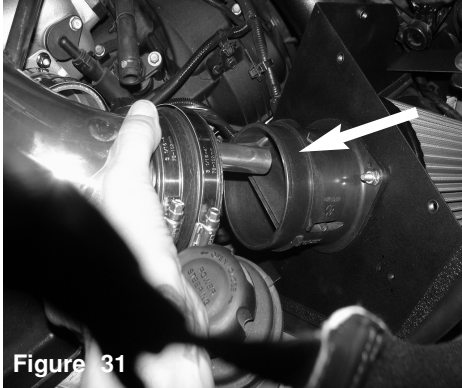


Figure 31

**Important:** When inserting air fusion tube into the mass air flow sensor step-hose, the air fusion tube **MUST BE** inserted into the un-metered side



Figure 32

Now when positioned correctly, you can tighten all the clamps using 8mm nut driver.

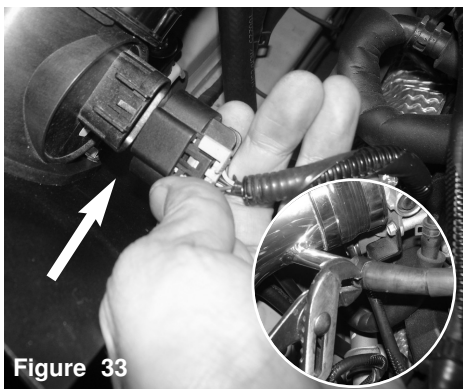


Figure 33

Re-connect the MAF sensor harness. With pliers, secure the crank case line to fitting on intake tube.



Figure 34

Install the cover to the heat shield and tighten using provided stainless allen screws.

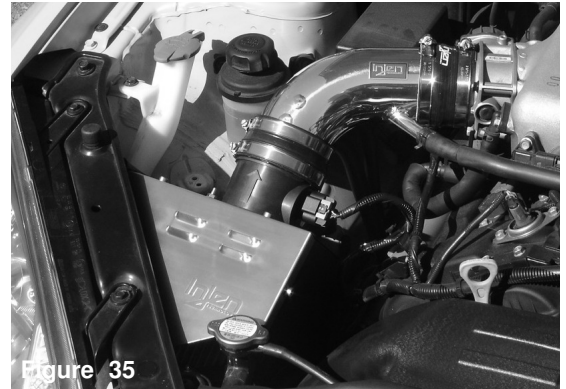


Figure 35

Congratulations! You have just completed the installation of the best cold air intake system you'll ever buy. Periodically, check the fitment and alignment for any shifting that could cause damage to the intake.

1. Upon completion of the installation, reconnect the negative battery terminal before you start the engine.
2. Align the entire intake system for the best possible fit. Once the intake has been properly fitted continue to tighten all nuts, bolts and clamps.
3. Periodically, recheck the alignment of the intake system and make sure there is proper clearance around and along the length of the intake. Failure to follow proper maintenance procedures may cause damage to the intake and will void the warranty.
4. Start the engine and listen carefully for any odd noises, rattles and/or air leaks prior to taking it for a test drive. If any problems arise go back and check the vacuum lines, hoses and clamps that maybe causing leaks or rattles and correct the problem.
5. Check the filter for excessive dirt build up. Clean or replace the filter with an original Injen filter (can be bought on-line at "injenonline.com"). Congratulations! You have just completed the installation of the best intake system sold on the market. Enjoy the added power and performance of your new intake system.