

X-PEDALPRO

THROTTLE CONTROLLER

BLACK EDITION



IMPORTANT

READ BEFORE INSTALLING



Important: Use extreme caution when using high settings

We strongly recommend only using settings 1-5 on daily driven street vehicle.

SETTING 6-9 SHOULD ONLY BE USED ON A RACE TRACK OR CLOSED-COURSE FACILITY. PLEASE USE SETTING 6-9 WITH EXTREME CAUTION, NOT INTENDED FOR LONG TERM USE!!!

NOTE: Most late model vehicles are equipped with a Torque Based Electronic Throttle Control (ETC). Settings 6-9 may trigger a CEL DTC P2138 - Throttle/Pedal Position Sensor/Switch 'D/E' Voltage Correlation code due to the X-Pedal creating a higher Accelerator Pedal Position (APP) Vs. (APP2) value when using settings 6-9. When a CEL DTC P2138 is triggered, the accelerator pedal may be completely disabled making the vehicle inoperable, causing an extremely dangerous situation

If a Check engine light is triggered, the vehicle will go into Limp Mode (Reduced Power Mode). You will have to put the vehicle into park or neutral and cycle the ignition completely off before trying to restart the vehicle. You will also have to reset the CEL DTC code from the vehicle with an OBD II scanner to get the vehicle out of Limp Mode (Reduced Power Mode).

Most vehicles manufactured today are equipped with a "Drive-by-wire" electronic accelerator pedal. Depending on the manufacture and the vehicle, the response time is pre-programmed into the ECM and can not be changed by the end user. The Injen X-Pedal modifies the signal between the O.E. electronic accelerator pedal and the electronic throttle body and increases or decreases the throttle response to user definable settings. By increasing the SportMode setting (SPORT), you can increase the engines response time making the low to mid RPM range come in sooner. This will make the vehicle feel faster with less throttle input. When increasing the Economy Mode (ECO) a delay is created in the throttle response time to achieve better fuel economy or less aggressive throttle response on vehicles pre-programmed with very aggressive throttle response.

X-Pedal Features:

- **9 Level Sport Mode (Sport)** - Each level increases throttle response by 4-6%. The driver can choose the power level that suites their driving style.
(LEVELS 7-9 RECOMMENDED FOR TRACK USE ONLY)
- **Drag Race Launch Control Mode** - Dramatically increases throttle response by removing any delay from the electric throttle accelerator pedal to the ECM, therefore lowering your reaction times.
(TRACK USE ONLY)
- **7 Level Economy Mode (Eco)** - Suitable for city driving, can effectively lower the fuel consumption.
- **Anti-Skid Mode** - Suitable for snow or slippery conditions. Helps reduce tire spin by delaying the throttle response at initial acceleration.
- **Anti-Theft Mode** - Completely disables the throttle signal to the ECM preventing vehicle theft or unauthorized vehicle use.
- **Stock Mode (Nor)** - Returns the throttle response back to stock
- **Simple Plug-n-Play Installation** - Install device in minutes with the optional model specif harness.

Important notice:

⚠ Please read entire instructions thoroughly for proper operation!!! ⚠

- Disconnect the negative terminal of the battery before installation to prevent any short circuits or damage to any electrical devices. Wait 10 minutes before you attempt to perform the installation so the CAN BUS system de-energizes.
- You must perform the initial setup after the first installation. You will need to sync the X-Pedal to the ECM or a check engine light may trigger.
- Make sure the engine is off and gear is in Park (P) or Neutral (N) position while running the initial setup.
- DO NOT attempt to make adjustments while driving. Any adjustments should be done while the vehicle is stationary and the vehicle in the Park (P) or Neutral (N) position.
- Professional knowledge of a vehicles electrical system is required. For any technical questions, please contact an Injen Technology customer service representative.
- Handle all wires carefully. Don't tug and pull on any cable as it can cause a short circuit and possibly damage the X-Pedal and the vehicles electrical system.
- Organize the wire after installation. Use zip ties (not included) to prevent the wires from getting yanked or pulling out of place and possibly creating a short circuit.
- If connecting the optional brake light signal wire or the reverse signal wire, make sure the wires are soldered and heat shrink wrapped to avoid any possible short circuits.
- Any defect or damage may arise from misuse, mishandling, abuse, accident, negligence and damage caused directly or indirectly by Customer, including but not limited to improper testing, installation, alteration or modification of any kind will not be covered under the warranty policy.
- DO NOT attempt to disassemble the product or modify any of the components as it will void your warranty.

⚠ Shut off the engine and disconnect the battery before you attempt to install this device

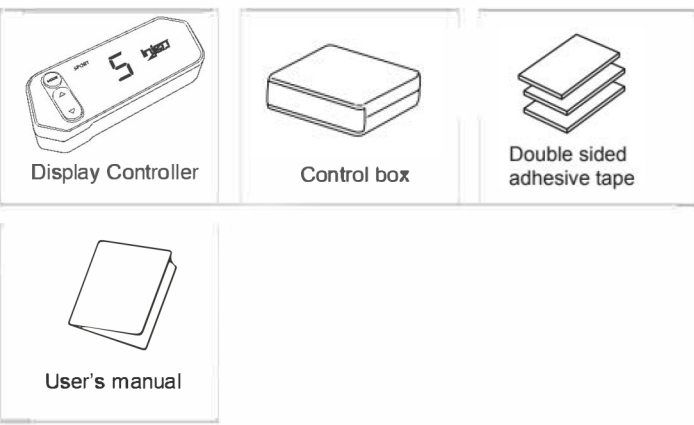

Harness: Disconnect the negative battery terminal

Preparation of installation

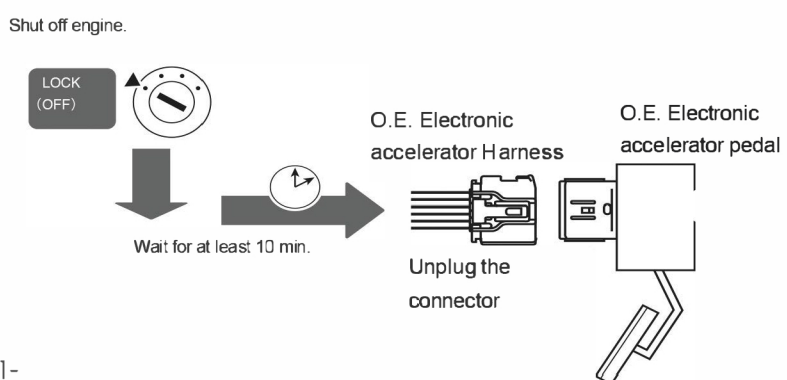

Simple Plug-n-Play Installation

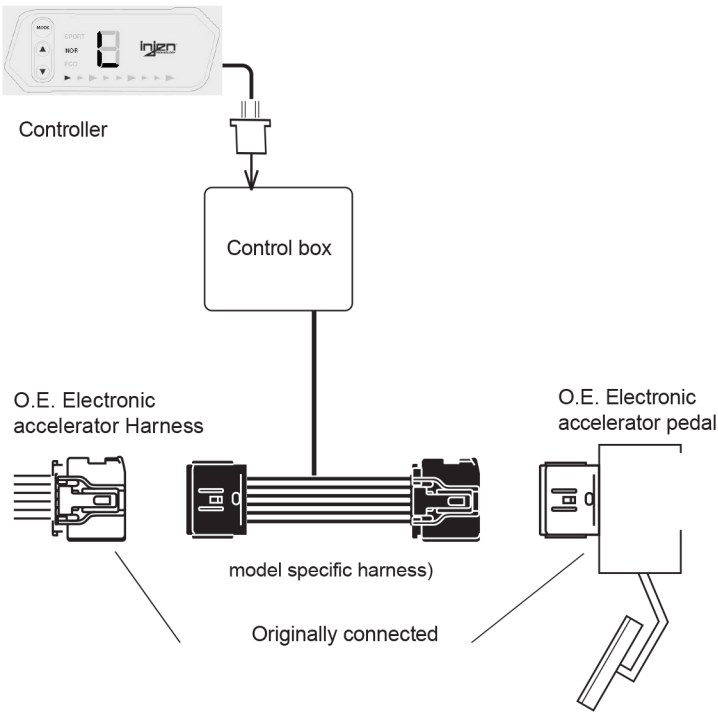

Port Diagram

(Rear view of control box)

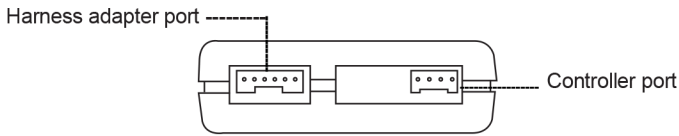

Initial Setup:

X-Pedal Display

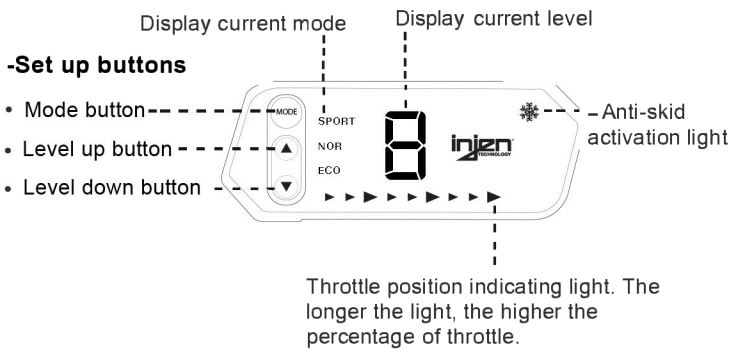

Display shut-down time:

- The monitor will remain on for 10 seconds to 5 minutes after engine is turned off. The unit will turn itself off once the ECM cuts power to the accelerator pedal.
- It is normal for the display to be on while the X-Pedal is shutting down.













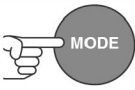

Syncing

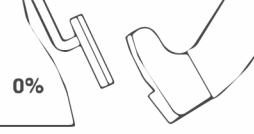







- You will have to sync the X-pedal to the ECM during the initial setup. Once you have synced the X-Pedal to the ECM, you will no longer have to sync again unless you intend on installing it on another vehicle.
- Do not use the X-Pedal until you sync the X-Pedal to the ECM or a check engine light will be triggered and may cause a dangerous driving situation.

Initial setup instruction

Syncing the X-Pedal to the ECM.

1. Turn the ignition on to the ACC II position and then shift the gear to Park "P" or Neutral "N" position while the engine is off. Make sure the display is on the (Nor) Mode

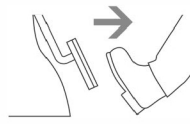
Steps	Code (shown on display)
<p>Turn the ignition switch to ACC II. The engine must be off</p>  <p>①</p>	 <p>Display 0</p> <p>Make sure the display is in the (Nor) Mode</p>
<p>Hold Mode button till the number counts down to "0"</p>  <p>Press and hold</p> <p>②</p>	 <p>The display will start to count back down from from 7,6,5...1,0</p>
<p>Release the Mode button.</p>  <p>Release</p> <p>③</p>	 <p>Letter "L" light is blinking the first throttle position indicating light is blinking.</p>
<p>Do not step on pedal so the X-Pedal can learn the 0% throttle position</p>  <p>④</p>	 <p>Letter "L" light is blinking the first throttle position indicating light is blinking.</p>
<p>Press  or </p>  <p>Press  </p> <p>⑤</p>	 <p>Letter "H" light is blinking Full throttle position indicating lights are all blinking</p>

	Code (shown on display)
<p>Floor the accelerator pedal so the X-Pedal can learn the 100% throttle position.</p>  <p>⑥</p>	 <p>Letter "H" light is blinking Full throttle position indicating lights are all blinking .</p>
<p>Press  or </p>  <p>Press </p> <p>⑦</p>	 <p>Full throttle position indicating lights are at 100%</p>
<p>The setup is complete when the battery indicating light is at 100%. You may release the accelerator</p>  <p>⑧</p>	 <p>When releasing the accelerator, the full throttle position indicating lights fall back to 0%.</p>

Syncing complete!

Please be sure to reset when installing in other cars.

To confirm the X-Pedal was synced correctly, press the "Mode" button to change Mode settings.

 <p>press </p>	 <p>flashing</p> <p>↓</p> <p>Nor</p> <p>Nor remains</p>
<p>If the  is flashing, you must go back to STEP "①".</p>	

 Please re-run the initial setup if the code is showing on the X-Pedal display.

Reset

- Please reset the X-Pedal when installing in other vehicle.
- Avoid check engine lights and drive ability issues

① Turn the ignition to the ACC II position  →

Make sure you are in the (Nor) Mode setting and the display is reading  →



② 



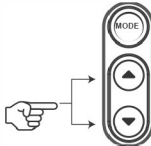

1 - Press and hold the Mode button. While it is counting down, hold "up" and "down" buttons at the same time. Wait for 2 seconds till the monitor shows "-". A reset was successful.

2 - At this point, pressing the Mode button won't switch between mode setting and will display a blinking "0"

Step shift

- Pressing the arrow up in (SPORT) Mode will increase the throttle percentage higher. The higher the setting, the more aggressive the throttle body opens up.
- Pressing the arrow up in (ECO) Mode will increase the delay in the throttle percentage. The higher the setting, the less aggressive the throttle body opens up

 Press  or  button, and it will increase or decrease the levels

	SPORT 1 → SPORT 2 ... SPORT 9
	ECO 1 → ECO 2 ... ECO 7
	SPORT 9 → SPORT 8 ... SPORT 1
	ECO 7 → ECO 6 ... ECO 1

Mode shift

Press "Mode" button to shift the mode.

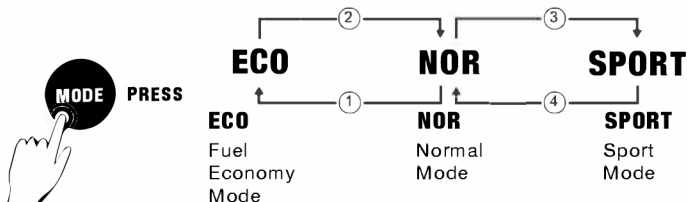

※ Each press of the MODE button will switch the Mode levels in the sequence order of ① ② ③ ④

Important notice:

We strongly recommend only using settings 1-5 on daily driven street vehicle.

NOTE: Most late model vehicles are equipped with a Torque Based Electronic Throttle Control (ETC). Settings 6-9 can trigger a CEL DTC P2138 - Throttle/Pedal Position Sensor/Switch 'D'/E' Voltage Correlation code due to the X-Pedal creating a higher Accelerator Pedal Position (APP) Vs. (APP2) value when using settings 6-9. When a CEL DTC P2138 is triggered, the accelerator pedal will be completely disabled making the vehicle inoperable, causing an extremely dangerous situation

SETTING 6-9 SHOULD ONLY BE USED ON A RACE TRACK OR CLOSED-COURSE FACILITY. PLEASE USE SETTING 6-9 WITH EXTREME CAUTION, NOT INTENDED FOR LONG TERM USE!!!

Acceleration and fuel consumption of each step

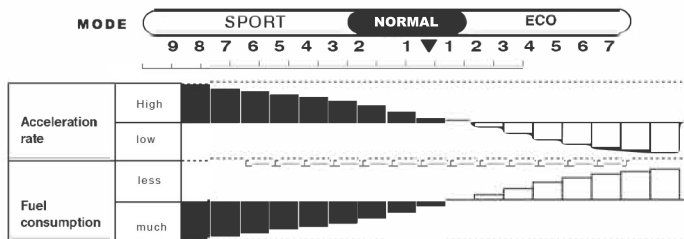

- The higher the (SPORT) setting the more sensitive and aggressive the throttle inputs get. Be cautious when making adjustments, especially when going in reverse without the reverse input option connected
- Be cautious when setting the (ECO) too high, as this will cause a delay in the throttle response and cause a dangerous situation when trying to pass or merge onto a street or highway

Activating Anti-skid function setup

- A. Activating Start Anti-skid mode



1. Under any mode or level, press UP and Down at the same time.



2. When the snow flake at the upper right corner lights up, and the number light turns off, Anti-skid mode is active

- B. Deactivate Anti-skid mode



Pressing any button will deactivate the Anti-skid mode.

DISCLAIMER OF LIABILITY

Injen Technology disclaims all liability for any special, direct, incidental or consequential damages, or any damages whatsoever, including, without limitation, the loss of life or limb, or damages due to bodily or personal injury, which may arise or result from the sale, installation, or use of any of its products and parts. It is the user's responsibility to inspect and verify the dimensions, specifications, performance and function of all products and parts as being appropriate for the use to which the user will put them prior to any actual installation and/or use of said products and parts.

The installation of Injen Technology products or parts may adversely affect other vehicle components, safety equipment or manufactured goods (collectively "goods"). Injen Technology assumes no responsibility for any damage to other goods, or bodily injury that may arise due to installation and/or use, either proper or improper, of its products or parts.

The liability of Injen Technology is limited to the replacement of defective products or parts found under examination by manufacturer to be defective in material or workmanship within 1 year after purchase, and which has not been caused by an accident, improper use, alteration, tampering, excessive use, misuse, modification or abuse.

Anti-theft function setup

- A. Activate anti-theft function



1. While in Eco mode, press and hold Mode button and wait for 2 seconds



2. Anti-Theft function is active when all the lights on the X-Pedal display turns off. While in Anti-Theft mode, the vehicles accelerator pedal is deactivated and will not respond to any throttle input.

- B. Deactivate anti-theft function



While the engine is running, press and hold Mode button and wait for 2 seconds until all the lights turn back on the X-Pedal display. The anti-theft function is disabled.

Launch Control function setup

- A. Activate launch control mode



1. While in (SPORT) mode, press and hold Mode button and wait for 2 seconds.



2. When the (SPORT) light and "number" light blink at the same time, the Launch Control Mode is activated.



Pressing any button will deactivate the Launch Control Mode



Caution:

Warning: BE EXTREMELY CAUTIOUS WHILE OPERATING THE VEHICLE WHILE LAUNCH CONTROL MODE IS ACTIVATED. LAUNCH CONTROL MODE IS EXTREMELY SENSITIVE AND WILL CREATE A FULL THROTTLE POSITION WITHIN A FEW DEGREES OF THROTTLE INPUT. LAUNCH CONTROL MODE SHOULD ONLY BE USED ON A RACE TRACK OR CLOSED-COURSE FACILITY. DO NOT ENGAGE REVERSE WHILE LAUNCH CONTROL FUNCTION IS ACTIVATED

Troubleshooting

Please verify if any event occurs below when the having trouble with the X-Pedal

SYMPTOM	CAUSE	TROUBLESHOOTING
X-Pedal unit	Plug-N-Play connector has bad connection to the OE accelerator pedal	Check all connectors and fittings
Check engine light is on	Battery not disconnected prior to installation	Reset check engine light with OBD II scanner
	X-Pedal not synced correctly to ECM	Follow the syncing procedure and make sure it is performed correctly
The display shows "0" and is blinking and won't switch out of Nor Mode	Syncing of the X-Pedal was performed incorrectly	Follow the syncing procedure and make sure it is performed correctly