

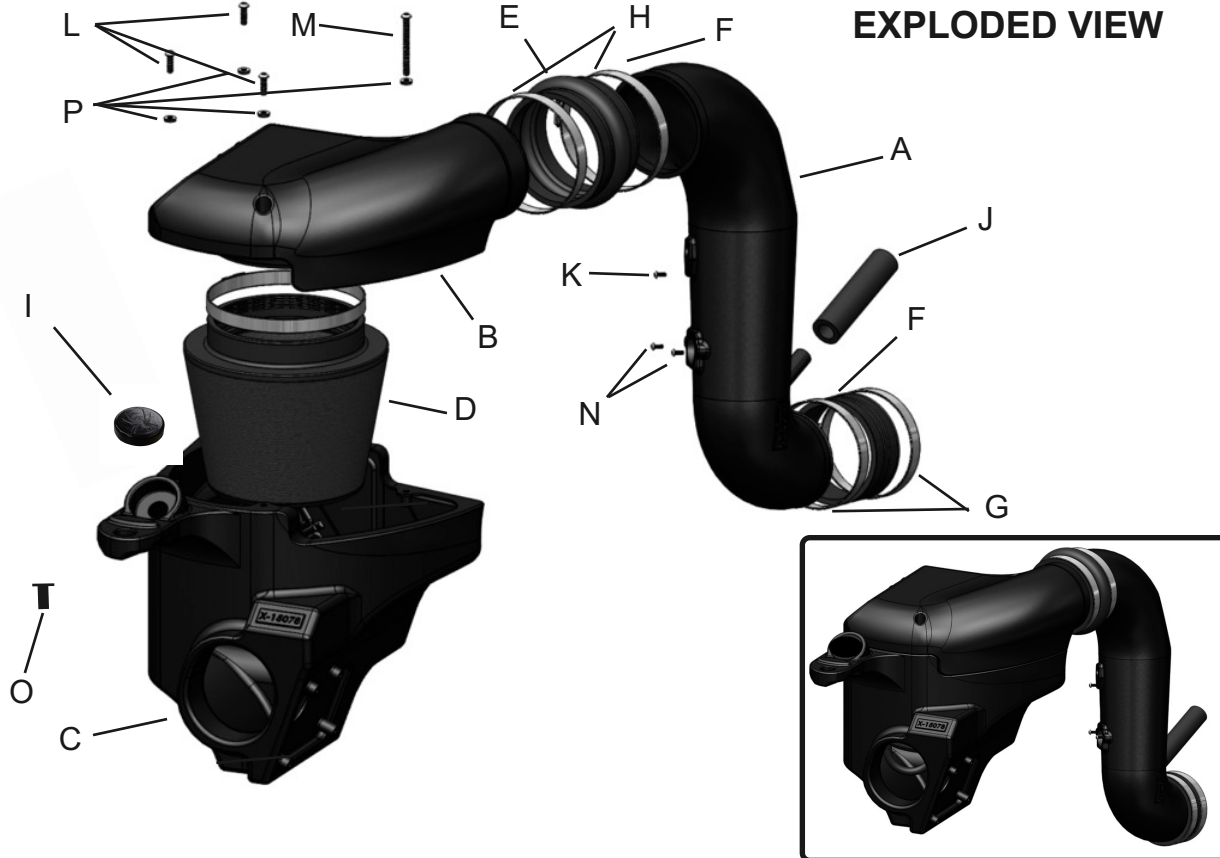

Vehicle Application:
 Make: **Dodge**
 Model: **Ram 2500/3500**
 Year: **2013-18**
 Engine: **6.7L Cummins Turbo Diesel**



EXPLODED VIEW

Item	QTY.	P/N	Discription
A	1	#15077	Rotomold intake tube
B	1	#15045	Rotomold Plenum
C	1	#15078	Rotomod Box
D	1	#1125	6.00" Filter
E	1	#3200	4.50" Hump Hose
F	1	#3129	4.00" Straight Hose
G	2	#4006	#64 Clamps
H	2	#4014	#72 Clamps
I	1	#6111	Filter Minder Plug
J	1	#3080	7"-15.9mm vacuum hose
K	1	#6072	M4X16 Button head Bolt
L	3	#6096	M6X25mm Bolt
M	1	#6095	M6X80mm Bolt
N	2	#6047	M4X10 Button head Bolt
O	1	#6068	M8X40 Bolt
P	4	#8047	1/2" OD Rubber seal washer

TOOLS REQUIRED

- 10mm Ratchet & Socket
- 8mm nut drive
- Allen key
- 7mm nut driver
- Philips

WARNING: FAILURE TO FOLLOW INSTALLATION INSTRUCTIONS AND NOT USING THE PROVIDED HARDWARE MAY DAMAGE THE INTAKE SYSTEM, ENGINE AND COMPONENTS!!!

***Do not attempt to install the intake system while the engine is hot.**
 Severe burn could result from touching hot engine components!

Report any defective or missing parts to the authorized Injen dealer you purchased this product from. Before installing any parts of this system, please read the instructions thoroughly. If you have any questions regarding installation, please contact your Injen Technology dealer. Installation DOES require some mechanical skills. A qualified mechanic is always recommended.

A Limited Lifetime Warranty to the original purchaser against defects in material and workmanship on all Injen intake systems excluding the filter element. Any and all warranty coverage is limited to the repair or replacement of the defective part only, at Injen Technology's discretion. The warranty does not cover incidental or consequential damages, nor does it cover the cost of installation or removal of the defective part or its replacement. Proof of purchase is required.

Instruction Manual P/N:EVO8007

NOTE: This intake kit may not work on vehicles with the following aftermarket modifications.

- Aftermarket Intercooler piping
- Aftermarket intercooler
- Turbo upgrade
- Modified body panels
- Suspension & Chassis modifications

Injen intake systems are street legal in most states unless the state is adopting to California Emissions standards. States that have adopted California emission standards include: Arizona, California, Connecticut, District of Columbia, Maine, Maryland, Massachusetts, New Jersey, New Mexico, New York, Oregon, Pennsylvania, Rhode Island, Vermont, and Washington. These states will require an California Air Resource Board Executive Order Number (CARB E.O.) for the legal use of an Injen intake system in your vehicle for use on public roads or highways. These vehicle will be considered "Legal in California only for racing vehicles competition use only, which may never be used upon a public street or highway. **Please keep your factory air box assembly for any future use.**

The SuperNano-Web filter media is a dry synthetic media that outperforms the competition. The media itself is a proprietary base blend of synthetics and cellulose. Cellulose fibers are larger than synthetic fibers, and have larger spaces between the fibers, causing contaminants to load in the depth of the media and plug the airflow path. This creates higher restriction levels and less capacity. The synthetic fibers in the SuperNano-Web media are submicron in diameter and have small interior fiber spaces, which result in more contaminants being captured on the surface of the media. This can help keep restriction levels low as the filter loads with dirt and containments



The image block contains the Injen Technology logo on the left. To the right is a large SEM image of the SuperNano-Web filter media, showing a dense, woven structure. Below the logo are two smaller SEM images: one labeled 'Existing media without Injen SuperNano-Web Technology' showing a loose, fibrous structure, and another labeled 'Superior Injen SuperNano-Web Technology' showing a much denser, more uniform web. At the bottom right of the image block is a spider icon and the text 'A New Generation of Filters Designed to perform and filter like no other' and 'INJEN SuperNano-Web Technology'.

If you look at the picture to the left, you can see the Nano-fiber web on top of our base media. That web, or SuperNano-Web as we like to call it, helps trap smaller particles and protect your engine.

To Clean your filter:

Carefully remove the filter from the housing. Once removed, wipe down the housing using a clean shop towel, being careful not to knock any dirt and/or debris in the air inlet. Your filters can be cleaned by carefully vacuuming the filter media from the dirty side, or by holding the filter with one hand and carefully blowing the filter media at a 45-degree angle from the clean side using low-pressure shop air (15-20 lbs. psi).

***IT IS IMPORTANT TO NOT USE ANY CLEANERS ON THE SUPERNANO-WEB MEDIA OR APPLY ANY OIL!!!**

NOTE: DISCONNECT BATTERY BEFORE INSTALLATION!!!

Instruction Manual P/N:EVO8007



1. Stock intake system shown.

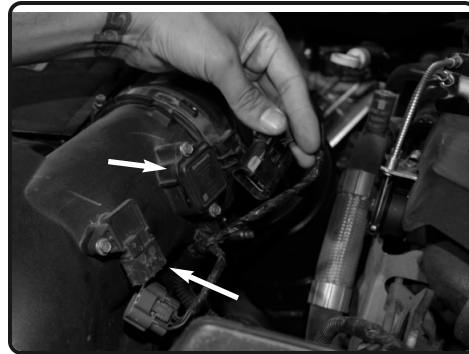

2. Disconnect the MAF/AIT sensor harness and then use a 7mm nut driver to loosen 3-7mm screws from the sensors. Remove sensors from the air box for now



3. Remove the 13mm bolt from the air box assembly on the radiator support.



4. Loosen the clamp from the air duct to the air box assembly and then pull the air duct from the air box.



5. Loosen the clamp and the CCV line on the air duct connected to the turbocharger inlet and crank case breather line and then remove the entire air duct.

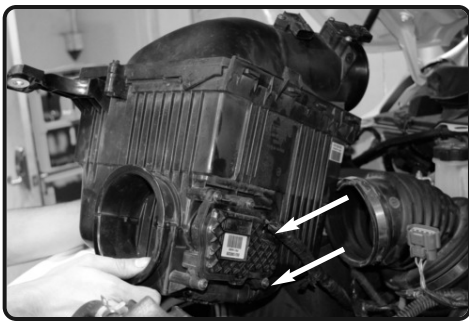

6. Firmly lift up on the entire air box assembly and remove it from the engine bay. Unscrew the active air duct motor assembly from the OE air box.

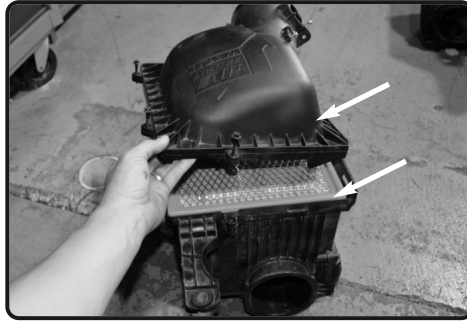

7. Loosen the screws to the upper air box and remove the air box top and filter to access the active air duct doors located in the lower air box assembly.



8. Locate the arm connected to the front active door inside the lower air box. Firmly disconnect the arm from the joint.

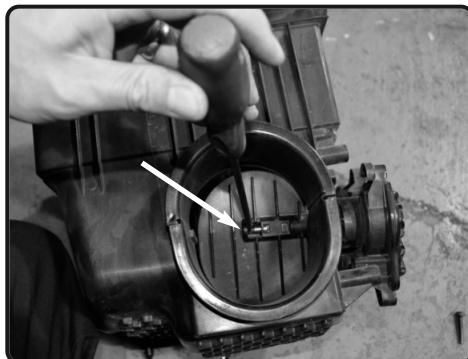

9. Use a skinny flat head screw driver and pry the tip of the shaft on the motor to remove the front door flap

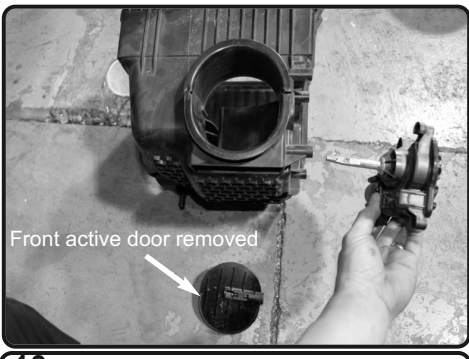

10. Once the front active door is removed, you will continue to install the motor and active door on the Injen air box assembly



11. Firmly press the active door back onto the motor on the Injen air box. Make sure the active door is fully bottomed out. An "Active Air Door" warning light may trigger if not properly installed.

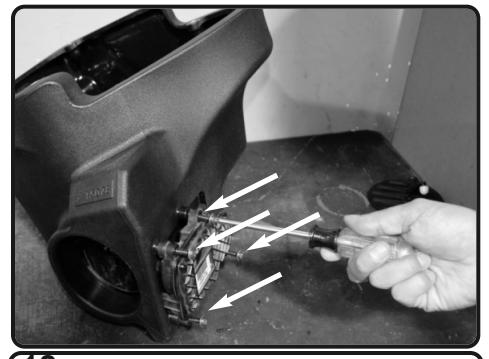

12. Re-use the 4 factory torx bolts and secure the motor to the Injen air box.

Instruction Manual P/N:EVO8007



13. Place the supplied Filter Monitor Plug into the lower air box assembly.



14. Place the filter and then place the plenum onto the 6.0" opening on the intake plenum.

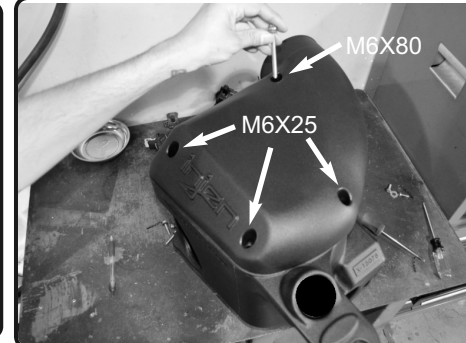

15. Place the plenum onto the lower air box and place 1-M6X80 and 3-M6X25 as illustrated in the photo.

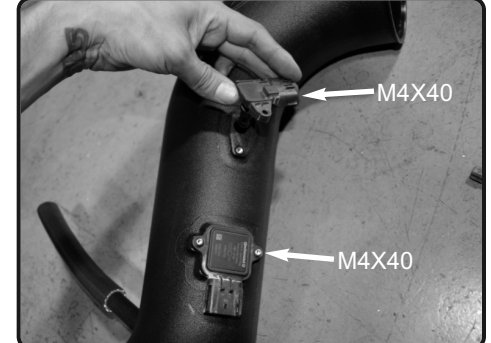

16. Place the MAF and air temp sensor onto the Injen intake tube and secure the temp sensor with a M4X40 bolt and the MAF sensor with two M4X16 bolts



17. Place the 4.00" straight hose and two #64 clamps on to the end of the Injen intake tube and then connect the 15.9mm vacuum to the port on the intake tube.



18. Attach the intake tube to the turbocharger and then connect the 15.9mm vacuum line to the CCV tube on the engine.

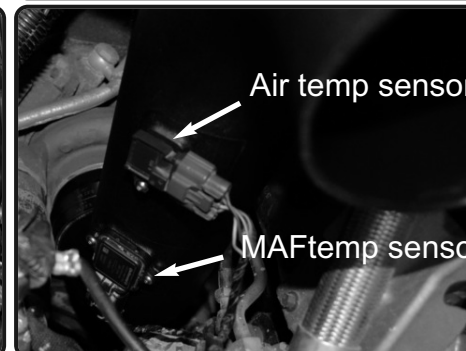

19. Once the tube is in place, re-connect the MAF and air temp sensor on the intake tube



20. Place the 4.50" hump hose and two #72 clamps onto the top end of the intake tube.

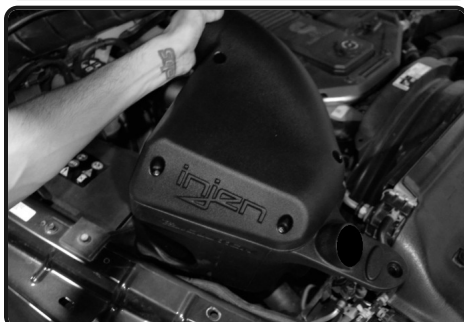

21. Lower the entire air box assembly into the engine bay. Make sure you line up the two mount tabs to the grommets on the chassis.

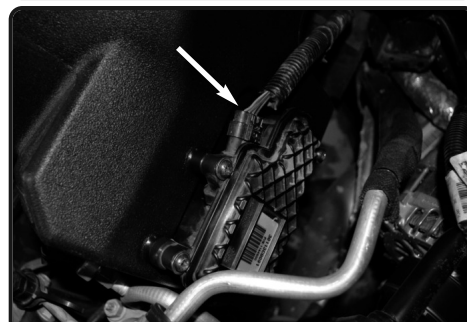

22. Re-connect the active door motor harness on the side of the air box.

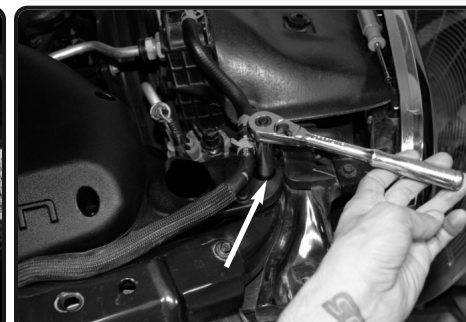

23. Use the M8X40 bolt to secure the air box bracket to the radiator support

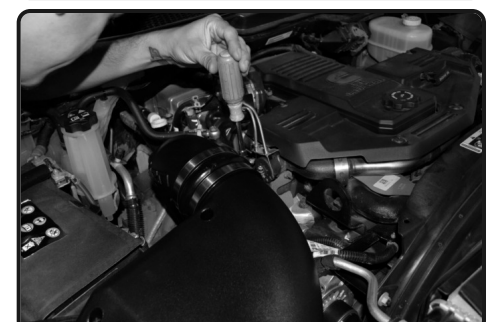

24. Slip the 4.50" hump hose over the air box plenum. Make sure it centered and the secure the clamps



Congratulations! You have just completed the installation of this intake system. Periodically, check the alignment of the intake, normal wear and tear can cause nuts and bolts to come loose.

Note: Check clearance and adjust if needed! Failure to check the alignment and adjust the intake can cause damage that will void the warranty. Injen Technology is not responsible for any damages caused by/from improper installation.

Test Drive:

1. With the transmission in neutral or park and the parking brake engaged, start the engine. Listen for air leaks or odd noises. If air leaks are detected, secure hoses and connections. For any odd noises, inspect entire system for cause and adjust intake as needed. The Injen intake will function identically to the factory system but will be louder and more powerful.
2. Perform a road test. Listen for odd noises or rattles and fix as necessary.
3. If there are no issues, continue to enjoy your added performance from the Injen performance Intake kit.
4. Injen Technology recommends you periodically check clearance and adjust if needed! Failure to check the alignment and adjust the intake can cause damage that will void the warranty. Injen Technology is not responsible for any damages caused by/from improper installation.

1. Upon completion of the installation, reconnect the negative battery terminal before you start the engine.
2. Align the entire intake system for the best possible fit. Once the intake has been properly fitted continue to tighten all nuts, bolts and clamps.
3. Periodically, recheck the alignment of the intake system and make sure there is proper clearance around and along the length of the intake. Failure to follow proper maintenance procedures may cause damage to the intake and will void the warranty.
4. Start the engine and listen carefully for any odd noises, rattles and/or air leaks prior to taking it for a test drive. If any problems arise go back and check the vacuum lines, hoses and clamps that maybe causing leaks or rattles and correct the problem.
5. Check the filter for excessive dirt build up. Clean or replace the filter with an original Injen filter (can be bought on-line at "injenonline.com"). Congratulations! You have just completed the installation of the best intake system sold on the market. Enjoy the added power and performance of your new intake system.