

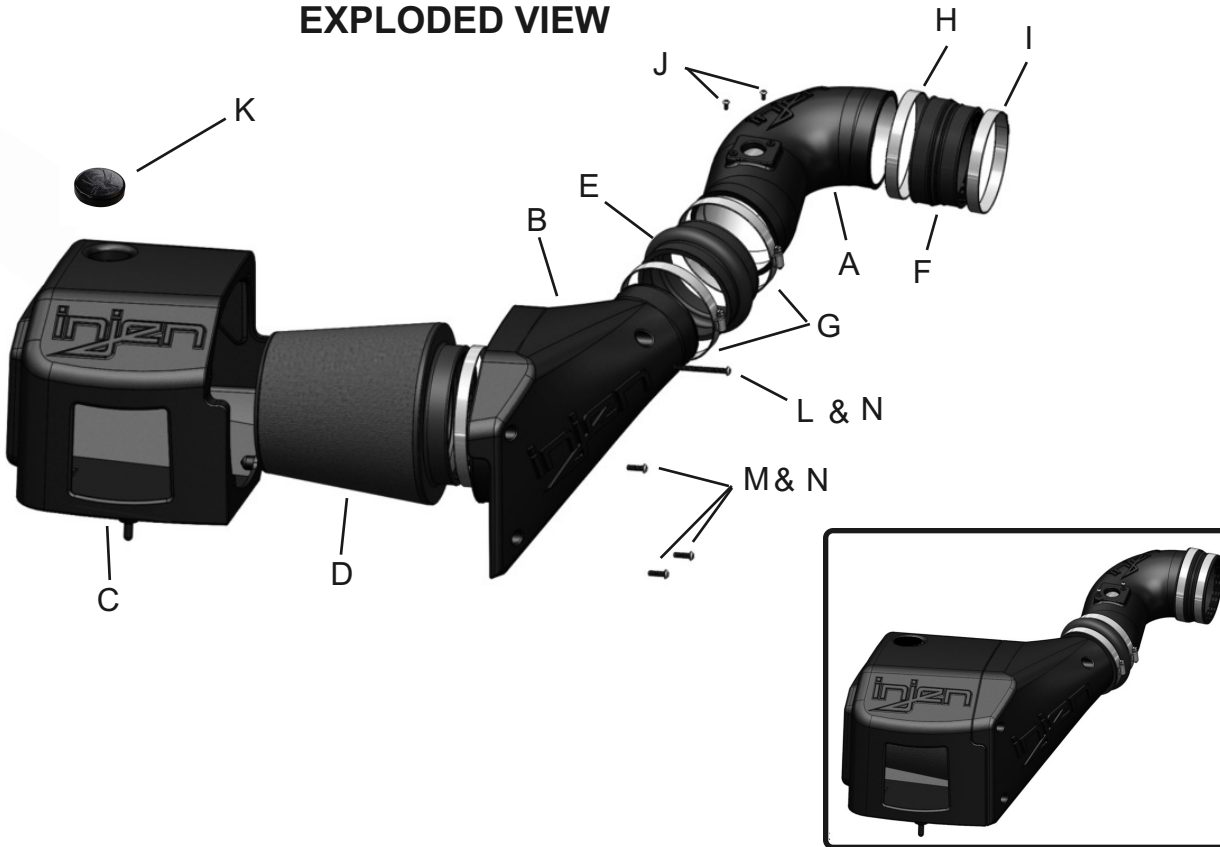

Vehicle Application:  
 Make: **Chevrolet /GMC**  
 Model: **Silverado / Sierra**  
**2500/3500**  
 Year: **2006-2007**  
 Engine: **6.6L (TD) Duramax LLZ**

**EXPLODED VIEW**



Item	QTY.	P/N	Discription
A	1	#15061	Rotomold Tube
B	1	#15053	Rotomold Plenum
C	1	#15051	Rotomold Box
D	1	#1101	6.00" Filter
E	1	#3200	4.50" Hump Hose
F	1	#3163	4.25"-4.50" Step Hose
G	2	#4019	#80 Clamps
H	1	#4014	#72 Clamp
I	1	#4006	#64 Clamp
J	2	#6047	M4X10mm Button Head Bolts
K	1	#6111	Filter Minder Plug
L	1	#6095	M6X80mm Bolt
M	3	#6096	M6x30mm bolt
N	4	#8047	1/2"OD rubber seal washer

**TOOLS REQUIRED**

- 10mm Ratchet & Socket
- 8mm nut drive
- Allen key
- Flat Blade Screwdriver
- Philllips Screwdriver

**WARNING:** FAILURE TO FOLLOW INSTALLATION INSTRUCTIONS AND NOT USING THE PROVIDED HARDWARE MAY DAMAGE THE INTAKE SYSTEM, ENGINE AND COMPONENTS!!!

**\*Do not attempt to install the intake system while the engine is hot.**

Severe burn could result from touching hot engine components!

Report any defective or missing parts to the authorized Injen dealer you purchased this product from. Before installing any parts of this system, please read the instructions thoroughly. If you have any questions regarding installation, please contact your Injen Technology dealer. Installation DOES require some mechanical skills. A qualified mechanic is always recommended.

A Limited Lifetime Warranty to the original purchaser against defects in material and workmanship on all Injen intake systems excluding the filter element. Any and all warranty coverage is limited to the repair or replacement of the defective part only, at Injen Technology's discretion. The warranty does not cover incidental or consequential damages, nor does it cover the cost of installation or removal of the defective part or its replacement. Proof of purchase is required.

# Instruction Manual P/N:EVO7010

**NOTE:** This intake kit may not work on vehicles with the following aftermarket modifications.

- Aftermarket Intercooler piping
- Aftermarket intercooler
- Turbo upgrade
- Modified body panels
- Suspension & Chassis modifications

The SuperNano-Web filter media is a dry synthetic media that outperforms the competition. The media itself is a proprietary base blend of synthetics and cellulose. Cellulose fibers are larger than synthetic fibers, and have larger spaces between the fibers, causing contaminants to load in the depth of the media and plug the airflow path. This creates higher restriction levels and less capacity. The synthetic fibers in the SuperNano-Web media are submicron in diameter and have small interior fiber spaces, which result in more contaminants being captured on the surface of the media. This can help keep restriction levels low as the filter loads with dirt and containments

# injen<sup>®</sup>

## TECHNOLOGY



Existing media without  
Injen SuperNano-Web Technology

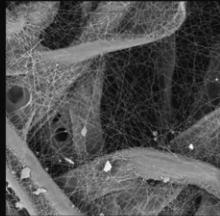

Superior Injen  
SuperNano-Web Technology

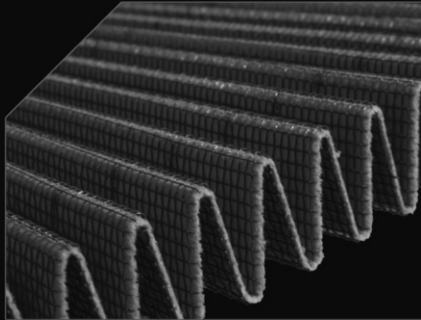

A New Generation of Filters  
Designed to perform and  
filter like no other

INJEN SuperNano-Web Technology

If you look at the picture to the left, you can see the Nano-fiber web on top of our base media. That web, or SuperNano-Web as we like to call it, helps trap smaller particles and protect your engine.

### **To Clean your filter:**

Carefully remove the filter from the housing. Once removed, wipe down the housing using a clean shop towel, being careful not to knock any dirt and/or debris in the air inlet. Your filters can be cleaned by carefully vacuuming the filter media from the dirty side, or by holding the filter with one hand and carefully blowing the filter media at a 45-degree angle from the clean side using low-pressure shop air (15-20 lbs. psi).

**\*IT IS IMPORTANT TO NOT USE ANY CLEANERS ON THE SUPERNANO-WEB MEDIA OR APPLY ANY OIL!!!**

## **Vehicle Emission Control Information:**

If your OE air box has a Vehicle Emission Control Information decal affixed to it, removing your OE air box will also remove the Vehicle Emission Control Information decal. A visible VEI decal must be visible in the engine compartment to be CARB compliant. The VEI decal must be affixed to a component that is not easily removable. You can purchase a replacement VEI decal from your local dealership. Failure to have a visible Vehicle Emissions Control information decal will prevent the vehicle from passing a smog test. Sample Vehicle Emission Control Information decal shown

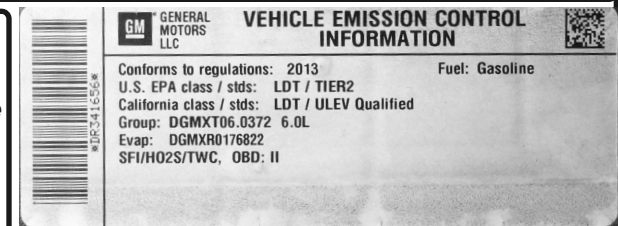

### **Note:**

**The C.A.R.B. Exempt sticker must be attached under the hood in a manner that is easily viewed by an emissions inspector.**

**NOTE: DISCONNECT BATTERY BEFORE INSTALLATION!!!**

# Instruction Manual P/N:EVO7010



1. Stock intake system shown.

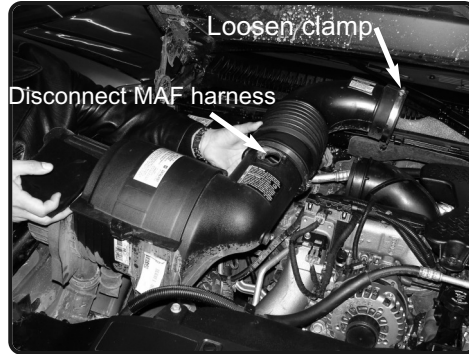

2. Disconnect the MAF sensor harness. Then loosen the clamp on the turbo inlet. Pull the entire air box assembly and air duct out of the engine bay.

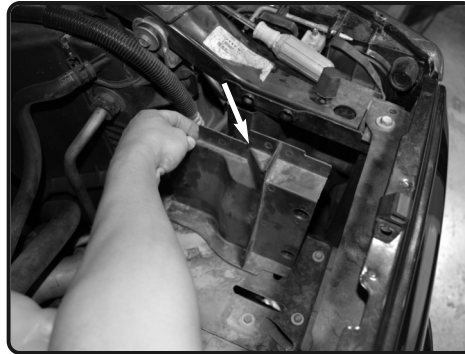

3. Remove the trim panel behind the passenger side headlight. Removing this panel will allow additional air into the intake system.



4. Place the Filter monitor plug into the drilled hole on top of the Injen air box.



5. Place the filter onto the the Injen intake plenum and then secure the clamp.

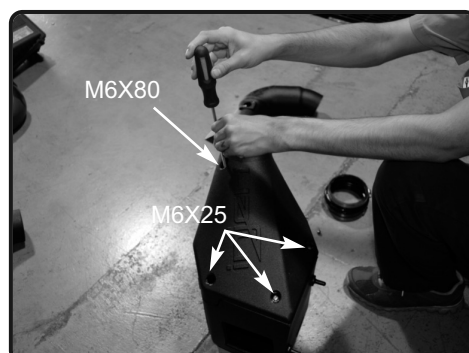

6. Place the three M6X25mm bolts and one M6X80mm into the plenum illustrated by the photo. Your Injen air box assembly is now complete.



7. Lower the Injen air box assembly into the engine bay. Make sure the pegs under the injen air box goes into the factory air box grommets located on the air box bracket.

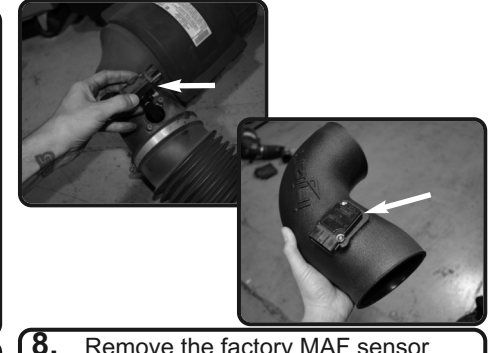

8. Remove the factory MAF sensor from the factory air box assembly and then install it into the Injen intake tube. Use two M4 supplied bolts to secure it to the tube.

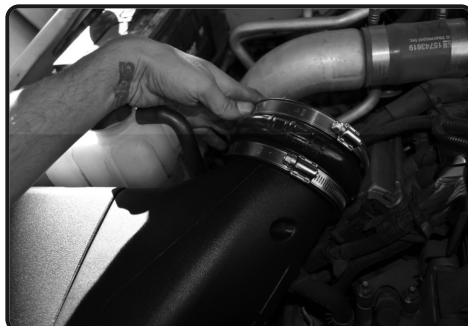

9. Place the 4.50" hump hose and two #80 clamps onto the Injen intake plenum. Secure the clamp on the plenum side for now.



10. Place the 4.25"-4.50" step hose and one #72 and #64 clamps onto the turbo inlet. Tighten the clamp on the turbo inlet side for now.



11. Insert the Injen intake tube into the 4.50" hump hose and the turbo end into the 4.25"-4.50" step hose. Once the intake is adjusted for best fitment, continue to secure the rest of the clamps



12. Re-connect the MAF sensor harness



Congratulations! You have just completed the installation of this intake system. Periodically, check the alignment of the intake, normal wear and tear can cause nuts and bolts to come loose. **Note: Check clearance and adjust if needed! Failure to check the alignment and adjust the intake can cause damage that will void the warranty. Injen Technology is not responsible for any damages caused by/from improper installation.**

## Test Drive:

1. With the transmission in neutral or park and the parking brake engaged, start the engine. Listen for air leaks or odd noises. If air leaks are detected, secure hoses and connections. For any odd noises, inspect entire system for cause and adjust intake as needed. The Injen intake will function identically to the factory system but will be louder and more powerful.
2. Perform a road test. Listen for odd noises or rattles and fix as necessary.
3. If there are no issues, continue to enjoy your added performance from the Injen performance Intake kit.
4. Injen Technology recommends you periodically check clearance and adjust if needed! Failure to check the alignment and adjust the intake can cause damage that will void the warranty. Injen Technology is not responsible for any damages caused by/from improper installation.

1. Upon completion of the installation, reconnect the negative battery terminal before you start the engine.
2. Align the entire intake system for the best possible fit. Once the intake has been properly fitted continue to tighten all nuts, bolts and clamps.
3. Periodically, recheck the alignment of the intake system and make sure there is proper clearance around and along the length of the intake. Failure to follow proper maintenance procedures may cause damage to the intake and will void the warranty.
4. Start the engine and listen carefully for any odd noises, rattles and/or air leaks prior to taking it for a test drive. If any problems arise go back and check the vacuum lines, hoses and clamps that maybe causing leaks or rattles and correct the problem.
5. Check the filter for excessive dirt build up. Clean or replace the filter with an original Injen filter (can be bought on-line at "injenonline.com"). Congratulations! You have just completed the installation of the best intake system sold on the market. Enjoy the added power and performance of your new intake system.