

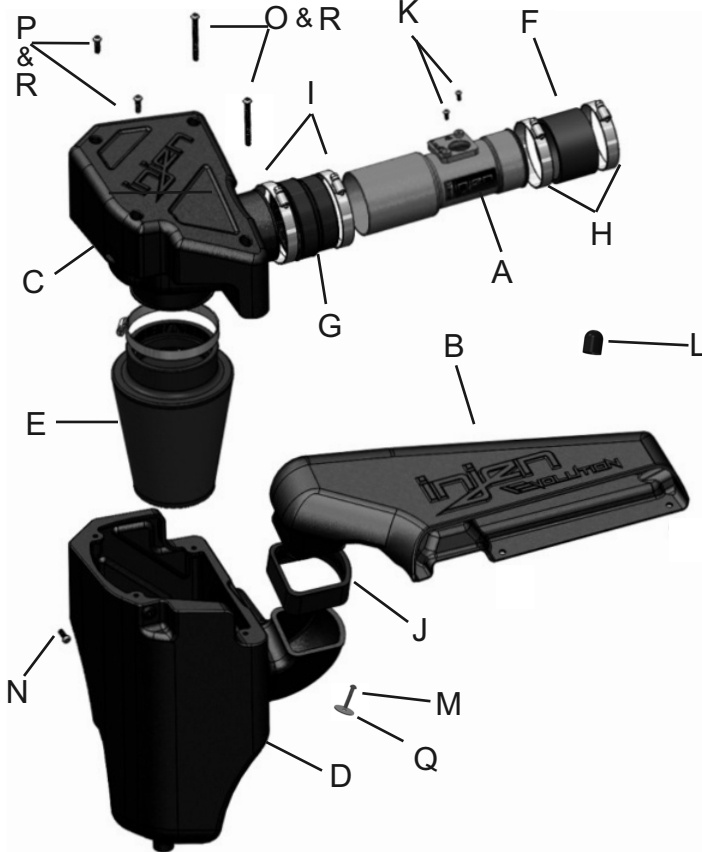

EXPLODED VIEW



Vehicle Application:  
 Make: **Subaru**  
 Model: **STi**  
 Year: **2015-2017**  
 Engine: **2.5L turbocharged BOXER 4-cyl.**

Item	QTY.	P/N	Description
A	1	Y-EVO1206	Intake Tube
B	1	#15063	Rotomold Air Scoop
C	1	#15065	Rotomold Plenum
D	1	#15064	Rotomold Box
E	1	#1070	Filter
F	1	#3050	2.875" Straight Hose
G	1	#3140	3.25"-3.50" Step Hose
H	2	#4004	#48 Clamps
I	2	#4005	#56 Clamp
J	1	#3204	Shur-Lok hose
K	2	#6047	M4X10mm Bolts
L	1	#8040	Vinyl Cap
M	1	#6007	M6x35mm Allen Bolt
N	1	#6083	M6x10mm Allen Bolt
O	2	#6095	M6X80mm Bolt
P	2	#6100	M6x20mm bolt
Q	1	#6010	Fender Washer
R	4	#8047	1/2"OD rubber seal washer

**TOOLS REQUIRED**

- 10mm Ratchet & Socket
- 8mm nut drive
- Allen key
- Flat Blade Screwdriver
- Phillips Screwdriver

**WARNING:** FAILURE TO FOLLOW INSTALLATION INSTRUCTIONS AND NOT USING THE PROVIDED HARDWARE MAY DAMAGE THE INTAKE SYSTEM, ENGINE AND COMPONENTS!!!  
\*Do not attempt to install the intake system while the engine is hot.  
 Severe burn could result from touching hot engine components!

Report any defective or missing parts to the authorized Injen dealer you purchased this product from. Before installing any parts of this system, please read the instructions thoroughly. If you have any questions regarding installation, please contact your Injen Technology dealer. Installation DOES require some mechanical skills. A qualified mechanic is always recommended.

A Limited Lifetime Warranty to the original purchaser against defects in material and workmanship on all Injen intake systems excluding the filter element. Any and all warranty coverage is limited to the repair or replacement of the defective part only, at Injen Technology's discretion. The warranty does not cover incidental or consequential damages, nor does it cover the cost of installation or removal of the defective part or its replacement. Proof of purchase is required.

# Instruction Manual P/N:EVO1206

**NOTE:** This intake kit may not work on vehicles with the following aftermarket modifications.

- Aftermarket Intercooler piping
- Aftermarket intercooler
- Turbo upgrade
- Modified body panels
- Suspension & Chassis modifications

Injen intake systems are street legal in most states unless the state is adopting to California Emissions standards. States that have adopted California emission standards include: Arizona, California, Connecticut, District of Columbia, Maine, Maryland, Massachusetts, New Jersey, New Mexico, New York, Oregon, Pennsylvania, Rhode Island, Vermont, and Washington. These states will require an California Air Resource Board Executive Order Number (CARB E.O.) for the legal use of an Injen intake system in your vehicle for use on public roads or highways. These vehicle will be considered "Legal in California only for racing vehicles competition use only, which may never be used upon a public street or highway. **Please keep your factory air box assembly for any future use.**



The SuperNano-Web filter media is a dry synthetic media that outperforms the competition. The media itself is a proprietary base blend of synthetics and cellulose. Cellulose fibers are larger than synthetic fibers, and have larger spaces between the fibers, causing contaminants to load in the depth of the media and plug the airflow path. This creates higher restriction levels and less capacity. The synthetic fibers in the SuperNano-Web media are submicron in diameter and have small interior fiber spaces, which result in more contaminants being captured on the surface of the media. This can help keep restriction levels low as the filter loads with dirt and containments

If you look at the picture to the left, you can see the Nano-fiber web on top of our base media. That web, or SuperNano-Web as we like to call it, helps trap smaller particles and protect your engine.

### **To Clean your filter:**

Carefully remove the filter from the housing. Once removed, wipe down the housing using a clean shop towel, being careful not to knock any dirt and/or debris in the air inlet. Your filters can be cleaned by carefully vacuuming the filter media from the dirty side, or by holding the filter with one hand and carefully blowing the filter media at a 45-degree angle from the clean side using low-pressure shop air (15-20 lbs. psi).

***\*IT IS IMPORTANT TO NOT USE ANY CLEANERS ON THE SUPERNANO-WEB MEDIA OR APPLY ANY OIL!!!***

**NOTE: DISCONNECT BATTERY BEFORE INSTALLATION!!!**

# Instruction Manual P/N:EVO1206

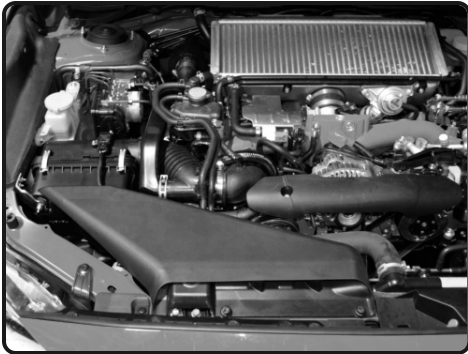

**1.** Stock intake system shown.

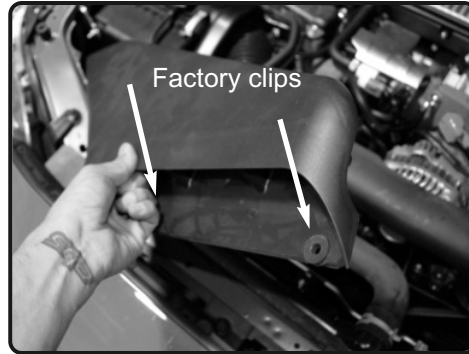

**2.** Remove the two plastic retaining rivets from the air scoop and remove scoop from engine bay. Save the clips for later installation.

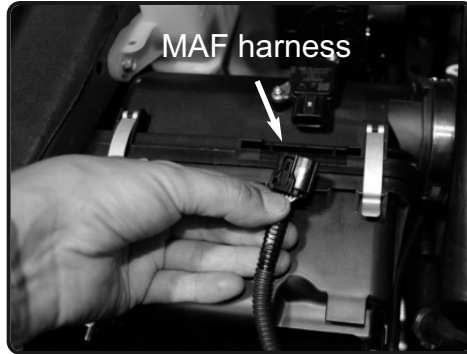

**7.** Disconnect the MAF sensor harness from the MAF sensor located on the top of the OE air box assembly.

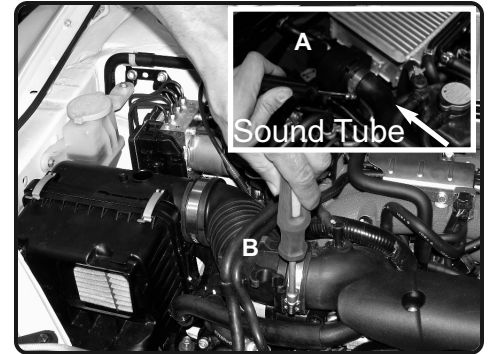

**3.** **A:** Loosen the clamp on the sound tube and then disconnect the tube from the valve. **B:** Loosen the clamp on the air box air duct and then disconnect the duct from the turbo inlet.

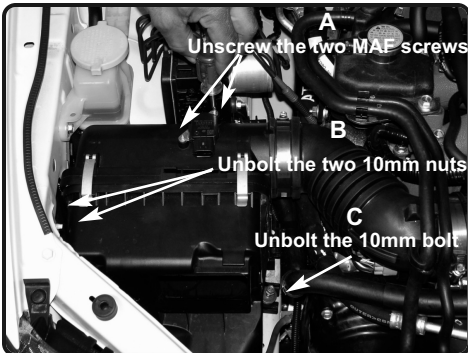

**4.** **A:** Unscrew the two screws from the MAF sensor. **B:** Unbolt the two 10mm nuts from the air box bracket to the chassis. **C:** Unbolt the 10mm bolt from the lower air box bracket

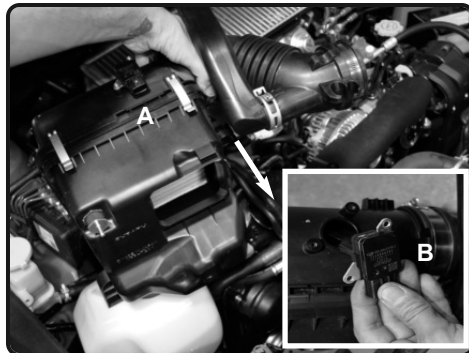

**5.** **A:** Carefully lift up and remove the entire stock air box assembly. **B:** Remove the OE MAF sensor from the stock air box assembly.



**6.** Install the provided vinyl cap to the sound tube accessory port.

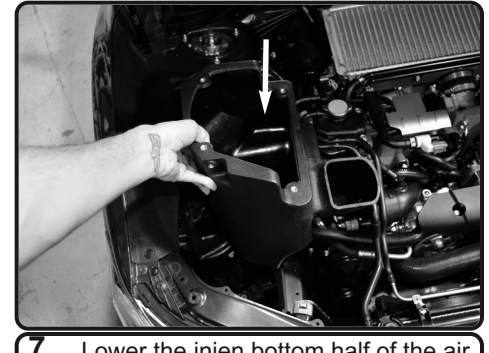

**7.** Lower the injen bottom half of the air box assembly into the vehicle and position the bracket on box to the vehicle frame.

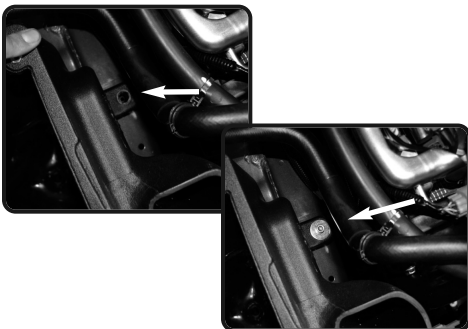

**8.** Locate the bracket, and with provided M6x35mm screw and fender washer secure the bottom of the injen air box.



**9.** Remove the factory bracket from the OEM air box.

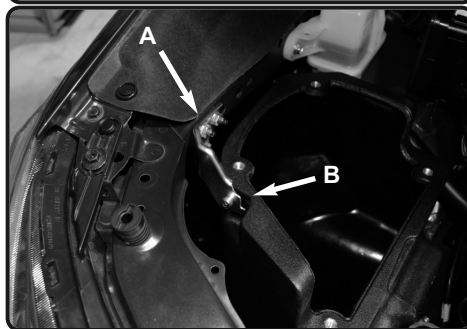

**10.** **A:** Re-install the bracket. Secure using OEM M6 nuts. **B:** Secure the bracket to the injen air box using provided m6x10mm. Secure and tighten the bracket.



**11.** Now install the filter on the upper plenum air box. Secure and tighten using 8mm nut driver.

# Instruction Manual P/N:EVO1206

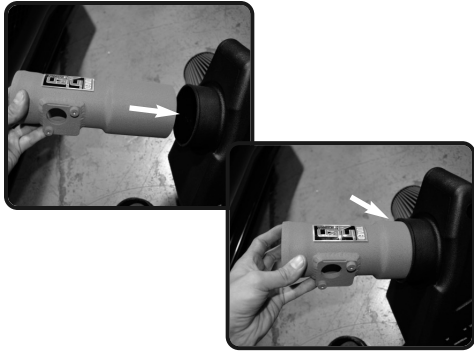

**12.** Please take a look at photo above, this is to show that the intake tube will be installed into the new injen air box plenum. Make sure the tube slides inside the air box. **Note: photos shown with out step hose.**

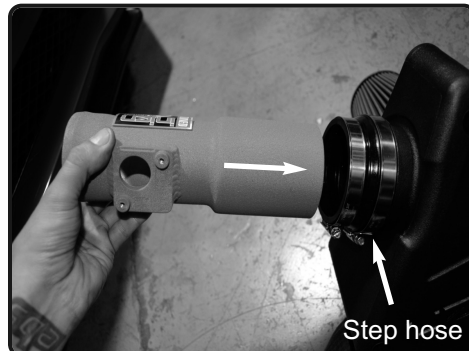

**13.** Install the step hose with clamps to the injen air box plenum. Install the intake tube and make sure the tube is inside the plenum.

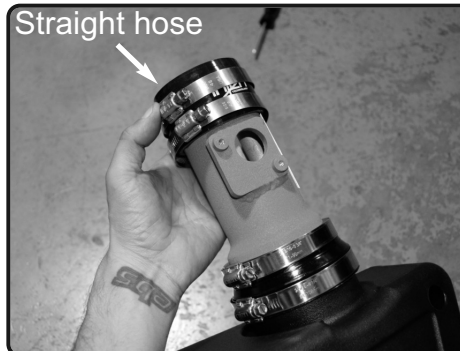

**14.** Install the straight hose with clamps provided to the intake tube. Do not tighten clamps.



**15.** Now install the upper intake assembly to the lower air box. Position the intake tube to the turbo housing.

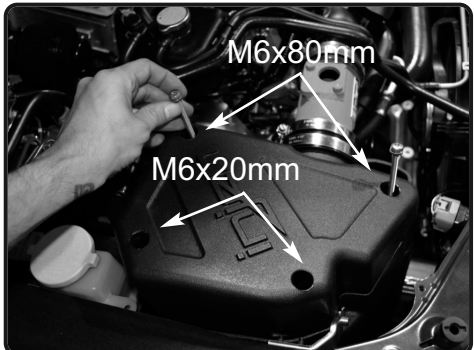

**16.** Secure the upper half of the air box. Secure the back using m6x80mm screws and front using m6x20mm screws.

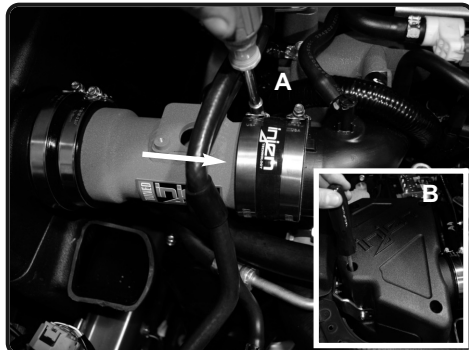

**17.** **A:** Slide the tube over till stops and hits the turbo housing. Tighten all clamps using 8mm nut driver. **B:** With phillips screwdriver, secure the top of the air box plenum and tighten all screws.



**18.** Install the MAF sensor into the new intake tube.



**19.** Now secure the MAF sensor and secure using provided M4 screws.



**20.** Connect the MAF sensor harness.



**21.** Remove the grommets from the factory scoop, attach to new scoop and secure.

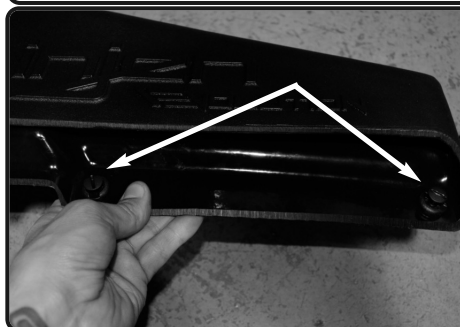

**22.** Now install the two retaining rivets.



**23.** Now install shur-lok hose to the fitting on the lower air box. **Note: Specific design to fit 1 way only.**



**24.** Now install the scoop to the shur-lock hose and secure.



**25.** Secure the rivets and turn using flathead screw driver. Make sure the scoop is secured.

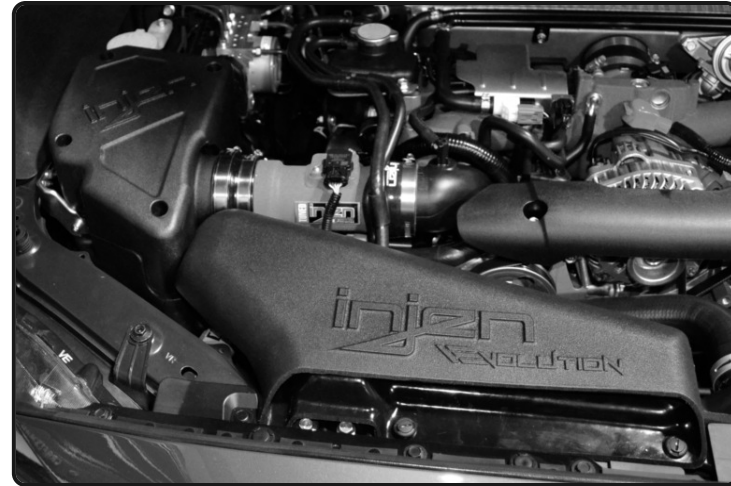

Congratulations! You have just completed the installation of this intake system. Periodically, check the alignment of the intake, normal wear and tear can cause nuts and bolts to come loose. **Note: Check clearance and adjust if needed! Failure to check the alignment and adjust the intake can cause damage that will void the warranty. Injen Technology is not responsible for any damages caused by/from improper installation.**

## Test Drive:

1. With the transmission in neutral or park and the parking brake engaged, start the engine. Listen for air leaks or odd noises. If air leaks are detected, secure hoses and connections. For any odd noises, inspect entire system for cause and adjust intake as needed. The Injen intake will function identically to the factory system but will be louder and more powerful.
2. Perform a road test. Listen for odd noises or rattles and fix as necessary.
3. If there are no issues, continue to enjoy your added performance from the Injen performance Intake kit.
4. Injen Technology recommends you periodically check clearance and adjust if needed! Failure to check the alignment and adjust the intake can cause damage that will void the warranty. Injen Technology is not responsible for any damages caused by/from improper installation.

1. Upon completion of the installation, reconnect the negative battery terminal before you start the engine.
2. Align the entire intake system for the best possible fit. Once the intake has been properly fitted continue to tighten all nuts, bolts and clamps.
3. Periodically, recheck the alignment of the intake system and make sure there is proper clearance around and along the length of the intake. Failure to follow proper maintenance procedures may cause damage to the intake and will void the warranty.
4. Start the engine and listen carefully for any odd noises, rattles and/or air leaks prior to taking it for a test drive. If any problems arise go back and check the vacuum lines, hoses and clamps that maybe causing leaks or rattles and correct the problem.
5. Check the filter for excessive dirt build up. Clean or replace the filter with an original Injen filter (can be bought on-line at "injenonline.com"). Congratulations! You have just completed the installation of the best intake system sold on the market. Enjoy the added power and performance of your new intake system.